

TOPWET[®]

FLAT ROOF
DRAINAGE SYSTEMS

TOPSAFE

FALL PROTECTION
SAFETY SYSTEMS



P R O D U C T C A T A L O G U E

TSF

TW[®]

Company data

TOPWET s.r.o.

náměstí Viléma Mrštíka 62
664 81 Ostrovačice
Czech Republic

GPS 49° 12' 36.81" N
16° 24' 34.19" E

Id.-Nr. 273 77 377

Tax-Nr. CZ27377377

Company divisions

TOPWET® | FLAT ROOF
DRAINAGE SYSTEMS

TOPWET Customer infoline

Orders, stock, invoicing
Mobile +420 601 350 730
E-mail export@topwet.cz

TOPWET Technical support line

Mobile +420 720 960 137
E-mail support@topwet.cz

www.topwet.cz

TOPSAFE | FALL PROTECTION
SAFETY SYSTEMS

TOPSAFE Customer infoline

Orders, stock, invoicing
Mobile +420 774 410 111
E-mail topsafe@topwet.cz

TOPSAFE Technical support line

Desing of projects
Mobile +420 774 410 112
E-mail projekty@topwet.cz

www.topsafe.cz

Content

TOPWET® | FLAT ROOF
DRAINAGE SYSTEMS

- 4 About
- 6 news
- 6 Penetrations for bituminous sheets
- 11 Self-regulating heated outlets and gutter overflows
- 12 Roof outlets
- 14 Outlet attachments and other accessories
- 16 Terrace outlets
- 18 Accessories for roof outlets, terrace outlets and attachments
- 20 Sanitation outlets and vents
- 22 Extended single-wall roof outlets
- 24 Balcony outlets
- 27 Inspection chamber for Green Roofs
- 28 Through wall outlets and safety overflows
- 31 Solutions for multi storey car parks – traverse outlets
- 32 Sealing sleeves – shaped pieces for waterproofing penetrations through PVC membranes
- 34 Vents and penetrations
- 38 Ventilation turbines
- 40 Edge dividers
- 41 Other roof elements
- 42 Siphonic drainage systems
- 46 Continuous balcony outlets and steel pipes

TOPSAFE | FALL PROTECTION
SAFETY SYSTEMS

- 48 What services are provided
- 49 Anchoring points for concrete construction
- 52 Anchoring points for trapezoid and sandwich constructions
- 54 Anchoring points for wooden constructions
- 56 Anchoring points for steel constructions
- 59 Anchoring points for rope suspension work
- 61 Rail systems
- 62 Anchoring points for inclined roofs
- 64 Collective protection
- 66 Systems for ladders
- 67 Industrial systems
- 71 Anti-slide pavements

About

Company history



TOPWET s.r.o is a company whose brand is recognised by industry specialists as **one of the leading European manufacturers of flat roof drainage products**. Our reputation has been gained mainly due our two layer roof outlets which integrate sleeves from flat roof waterproofing materials and gutter overflows with lowered overflow

Thanks to its extensive range of high quality products and experienced employees, a small firm established in 2000 has evolved into a company that has been constantly expanding and exporting its products all over Europe, becoming one of the leaders in the industry.

Quality & Development

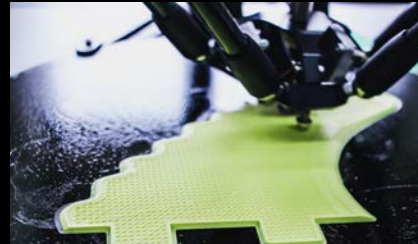

In order for the company to maintain its reputation in the industry, and increase market share, we need to continue to innovate and respond to our customers requirements and market conditions using the most advanced materials and technologies such as 3D printing.

Our research and development department continually test our products prior to mass production. Before manufacturing commences we produce a prototype which is tested to assess the shape, function, performance and compliance with current legislation. This is the only way we can guarantee the high quality of our products and their long term sustainability.

Products certification



All our products are manufactured to the highest quality standards. We rigorously test all our products to ensure certification and compliance with up to date legislation required by European organisations.

Our products are fully compatible with European rainwater pipe diameters and meet the demanding testing conditions required by the LGA testing laboratory ensuring compliance with European standards.



Client support



Customer satisfaction is our top priority at TOPWET and key to maintaining our long term relationships. Our customer relationships have been established for many years and built from our ability to adapt to our customers requirements.

Committed to customer service we provide seminars and training on all our products and participate in trade fairs in the Czech Republic and abroad. As part of our customer service we provide the following:

- ✔ Customer satisfaction,
- ✔ Ease of access to technical information,
- ✔ High quality and timely technical assistance,
- ✔ Effective forms of communication,
- ✔ Saving time and energy spent on problem solving and technical issues.

Technical support

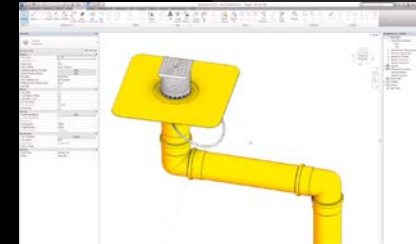

Due to the nature of our products, and our desire to provide high quality customer service, we offer a full technical support service to our customers at design stage and implementation.

SERVICES FOR ROOFING CONTRACTORS

- ✔ Technical support and consultancy
- ✔ Technical documentation and drawings
- ✔ Application drawings in 2D / 3D
- ✔ Certification and declarations of conformity
- ✔ Custom made products

SERVICES FOR DESIGNERS

- ✔ Technical drawings in DWG format
- ✔ Examples of application in 2D / 3D / PDF / DWG
- ✔ Consultancy, drainage calculations

If you have any questions, even directly from the construction site, we have technicians with specialist knowledge.

Transportation



Fast and reliable delivery of goods to our customers is one of our priorities. Available through our agents or distributors, we can even deliver direct to your construction site.

NEWS

TOPWET®

Penetrations for bituminous sheets

An established product in a new version

- Easy and reliable installation
- 100 % Waterproofness
- Vents in black colour to match the bituminous roofs



TOPSAFE

Rail systems

Safe façade maintenance

- Intended for work via rope access
- Designed for work in predefined positions
- Smooth movement along the whole length of rail lines

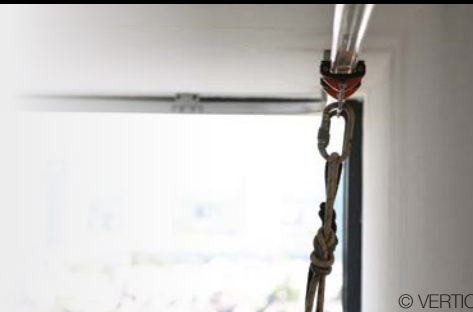

© VERTIC

TOPWET®

FLAT ROOF
DRAINAGE SYSTEMS

Outlets for flat roofs, terraces, balconies
Sealing sleeves

www.topwet.cz

Technical information

Documentation

Technical drawings and examples of drainage

Scaled technical drawings are provided complete with corresponding dimensions. Top Wet provide a vast library of standard details of our products used in a multitude of applications.

- **PDF format**
To facilitate simple viewing and printing
- **DWG format**
To enable our products to be incorporate into your own drawings
- **RFA format**
NEW
3D modelling of our products for incorporation into the building model using REVIT

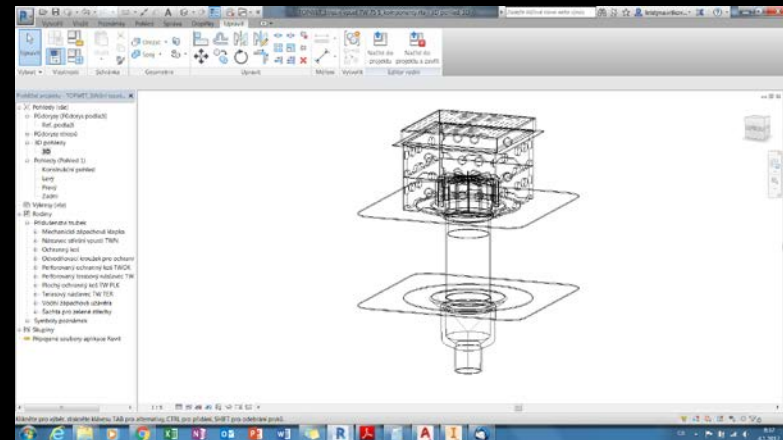
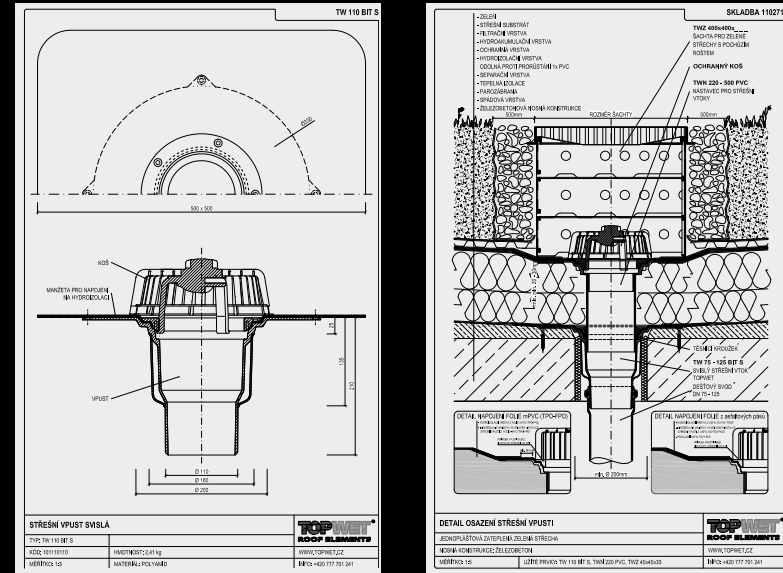

Roof Waterproofing Sleeve

TOPWET company supplies standardly all own products with integrated bitumen and PVC sleeve waterproof to ensure 100% reliable waterproof connection.

- **100% waterproof**
- **Secret fix fixing points**
- **Fully compatible with roof waterproofing system**



BIT
Supplied with a UV stable SBS bitumen sleeve for direct welding to the main waterproofing layer.



PVC
Supplied with a 1.5mm mPVC sleeve. All outlets can be manufactured with a specific manufacturers membrane (subject to additional cost).

TOPWET are the only manufacturer in the Czech Republic that offers the option to supply outlets, overflows and vents with the sleeve manufactured from a specific manufacturers waterproofing materials.

Products with custom manufacturers waterproofing sleeve are subject to the following conditions:

- The specific waterproofing material must be supplied to Topwet free of charge and will not be included in the cost of the manufacture of the end product
- Size of the sleeve must be 0,5 m x 0,5 m
- Manufacturing time will be 5 days from receipt of the waterproofing material (up to 20 pieces)
- A setup charge will be applicable. Please consult us for further information.
- We reserve the right to reject contaminated material and return it at the expense of the customer.



TPO (FPO)
Thermoplastic (flexible) polyolefin. A minimum thickness of 1.5mm, ideally in a homogenous version, is required. We currently produce with materials from the following brands:
Bauder, Carlisle, Eurotec, Fatra, Firestone, Flagon, Icopal, Sika & Texus, etc.

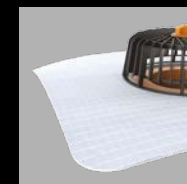

PE
Polyethylene is a vapour resistant membrane that is used mostly on roofs with a light structure.





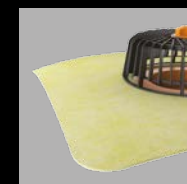



EPDM
A membrane of synthetic caoutchouc (natural rubber). We currently manufacture with flanges from the following brands:
Carlisle, Firestone, Pirelli, Saargummi

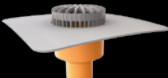

STE
A flange for connection to liquid waterproofing applications. Customer may supply their own flange or we will provide a special flexible flange with double sided integrated layer for connection to the liquid waterproofing.

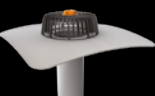
Combination options of products and accessories

	TWN Roof outlet attachments page 15	TWZU KL Mechanical roof flap page 19	TWZU Water odour trap page 19	TWOK Basket for gravel page 19	TW TER Terrace attachment page 19	TW PLK Walkable leaf guard page 19	TW ODK Balcony attachment page 19	TWZ Inspection chamber for green roofs page 27
Roof outlets page 13		✓	✓	✓	✓	✓	✓	✓
Roof outlet attachments page 15			✓	✓	✓	✓	✓	✓
Terrace outlets page 17			✓	✓	✓	✓	✓	✓
Sanitation outlets page 19				✓	✓	✓	✓	✓
Sanitation outlets BZ page 21								✓
Extended outlets page 23				✓	✓	✓	✓	✓
Extended outlets BZ page 23								✓

Self-regulating heated outlets and gutter overflows

Drainage of flat roofs

Self-regulating electric heating of outlets and gutter overflows ensures reliable drainage during the winter season. The system works by resistance change bto semiconductors due to ambient temperature changes. During the winter periods outlets are at risk of blocking due to ice or snow build up. The heating element is designed to protect not only the orifice of the outlet but its immediate surroundings as well.

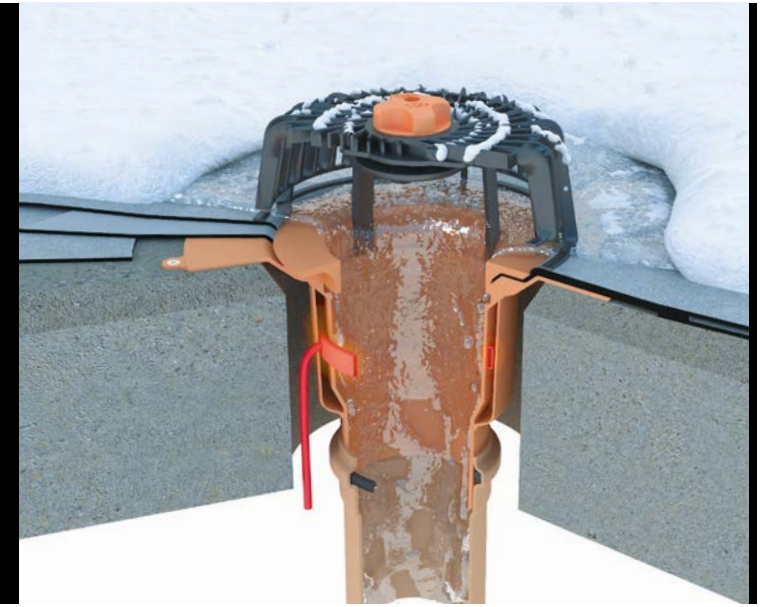

Advantages of self-regulation heating

- Reliable drainage in winter season
- Voltage 230 V / 50 Hz – without necessity of a transformer or a control unit

- Option of connection to heating of gutters, downpipes, entries etc.
- Simple connection via a switch or a thermostat
- Electric energy saving

Connection description

- Connection is performed in an electric box under roof structure
- Length of the outlet supply cable is 1.5 m. Cable CYKY 3 x 1.5 mm
- Wire connection: yellow-green/protective, black/phase, blue/neutral
- AC voltage: 230 V, 50 Hz
- Input power: 7 W at 20 °C – 10 W at 0 °C – 14 W at -20 °C
- Max. current surge: 89 mA
- Protection class: IP 67

Basic options of connecting of heated outlets

- Without possibility of switching off (energy consumption also in summer season – not recommended)
- Mechanical switch (manipulation required), or time socket
- Outer thermostat with integrated thermal sensor
- Thermostat to a switchboard including thermal sensor for measuring of external temperature
- Thermostat to a switchboard including thermal and humidity sensor for measuring the outside temperature

Wiring diagram

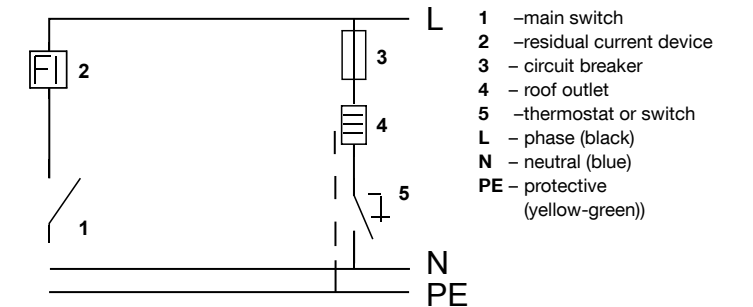

Roof outlets

Drainage of flat roofs

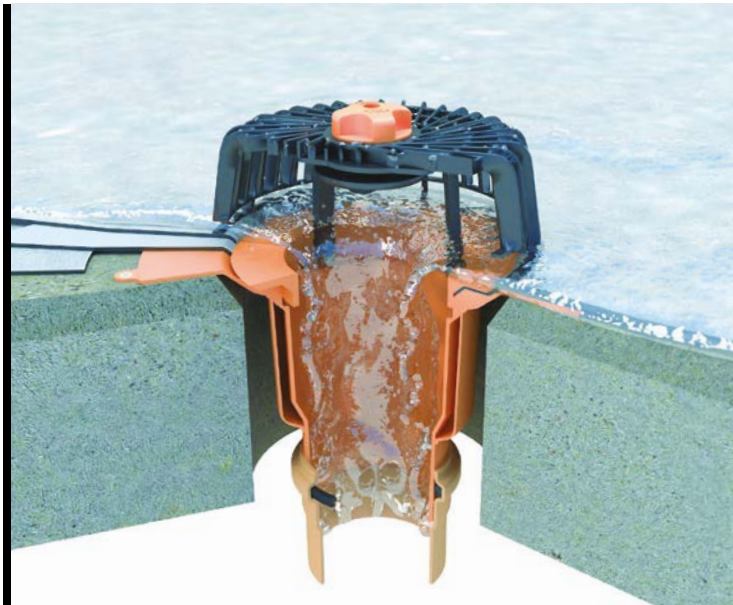

Basic type – thermally insulated vertical roof outlet

- Double-wall structure of polyamide PA6
- Integral flange of waterproof membrane or vapour barrier
- Leaf / debris guard supplied with each outlet
- Direct connection to vertical roof downpipes of DN 70, DN 100, DN 125 and DN 150 diameters

Complementary type – horizontal roof outlet

- Direct connection to horizontal piping of DN 70, DN 100 and DN 125 diameters
- Reduced construction height for warm roofs

Dimensions of vertical roof outlets

Type	DN	Dimensions [mm]					
		a	b	c	d	e	f
TW(E) 75 S	70	330	210	145	25	160	200
TW(E) 110 S	100	330	210	135	25	160	200
TW(E) 125 S	125	330	210	135	25	160	200
TW(E) 160 S	150	342	210	135	25	190	265

TW S

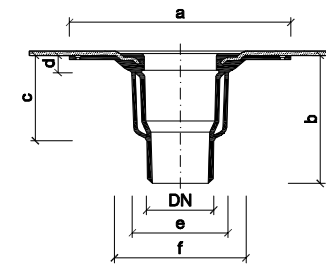

TWE S

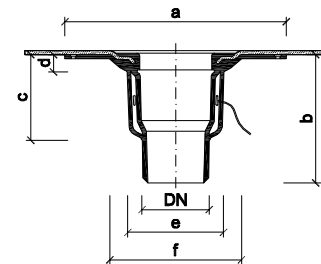

Dimensions of horizontal roof outlets

Type	DN	Dimensions [mm]						
		a	b	c	d	e	f	g
TW(E) 75 V	70	330	200	130	121	36	224 (238*)	46
TW(E) 110 V	100	330	200	130	157	25	238 (250*)	47
TW(E) 125 V	125	330	200	130	165	25	239 (251*)	40

TW V

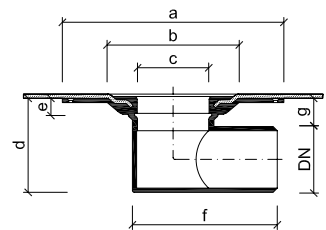

TWE V

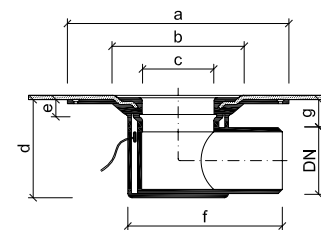

* dimensions of heated version

TOPWET roof outlets with integrated bitumen sleeve

BIT	Version	Type	Dimensions
	TOPWET roof outlet with an integrated flange of modified bitumen strip, vertical version, heat-insulated – double-wall with a leaf guard	TW 75 BIT S TW 110 BIT S TW 125 BIT S TW 160 BIT S XL	DN 70 DN 100 DN 125 DN 150
	TOPWET roof outlet with an integrated flange of modified bitumen strip, vertical version, heat-insulated – double-wall with a leaf guard, heated with 230 V, with a connecting cable	TWE 75 BIT S TWE 110 BIT S TWE 125 BIT S TWE 160 BIT S XL	DN 70 DN 100 DN 125 DN 150
	TOPWET roof outlet with an integrated flange of modified bitumen strip, horizontal version, with a leaf guard	TW 75 BIT V TW 110 BIT V TW 125 BIT V	DN 70 DN 100 DN 125
	TOPWET roof outlet with an integrated flange of modified bitumen strip, horizontal version, with a leaf guard, heated with 230 V, with a connecting cable	TWE 75 BIT V TWE 110 BIT V TWE 125 BIT V	DN 70 DN 100 DN 125

Option to supply with custom made sleeve (EPDM, TPO, FPO, PR, STE - suitable for cold liquid applied applications. For more information please see page 9.

TOPWET roof outlets with integrated PVC sleeve

PVC	Version	Type	Dimensions
	TOPWET roof outlet with an integrated sleeve of a waterproofing membrane based on PVC, vertical version, heat-insulated – double-wall with a leaf guard	TW 75 PVC S TW 110 PVC S TW 125 PVC S TW 160 PVC S XL	DN 70 DN 100 DN 125 DN 150
	TOPWET roof outlet with an integrated sleeve of a waterproofing membrane based on PVC, vertical version, heat-insulated – double-wall with a leaf guard, heated with 230 V, with a connecting cable	TWE 75 PVC S TWE 110 PVC S TWE 125 PVC S TWE 160 PVC S XL	DN 70 DN 100 DN 125 DN 150
	TOPWET roof outlet with an integrated sleeve of a waterproofing membrane based on PVC, horizontal version, with a leaf guard	TW 75 PVC V TW 110 PVC V TW 125 PVC V	DN 70 DN 100 DN 125
	TOPWET roof outlet with an integrated sleeve of a waterproofing membrane based on PVC, horizontal version, with a leaf guard, heated with 230 V, with a connecting cable	TWE 75 PVC V TWE 110 PVC V TWE 125 PVC V	DN 70 DN 100 DN 125

Option to supply with custom made sleeve (EPDM, TPO, FPO, PR, STE - suitable for cold liquid applied applications. For more information please see page 9.

Outlet attachments and other accessories

Drainage of insulated roofs



Basic type – universal performance

- Applicable for roof outlets of DN 70, DN 100 and DN 125 diameters, outlets vertical and horizontal including heated ones
- Height depending on Insulation thickness ranging from 40mm
- Suitable for passive houses with an insulation height up to 500 mm
- Sealing ring protecting against raised water included
- Heated version on request

Complementary type XL

- Only for vertical roof outlets of DN 150 diameter including heated ones

Assembly of two-stage outlets

- 100% vapour barrier
- Limitation of condensation thanks to the second wall
- Water drainage from vapour barrier level in the time of construction
- Sealing against raised water and dampness

The two part outlet is made of of an integral roof outlet that is fixed to an additional outlet sealed at the vapour control level. The bottom outlet is a twin wall construction preventing the flowing cold water to condensate. The top outlet is sealed with a gasket to prevent dirt entering into the lower outlet or the back flow of water under the thermal insulation.

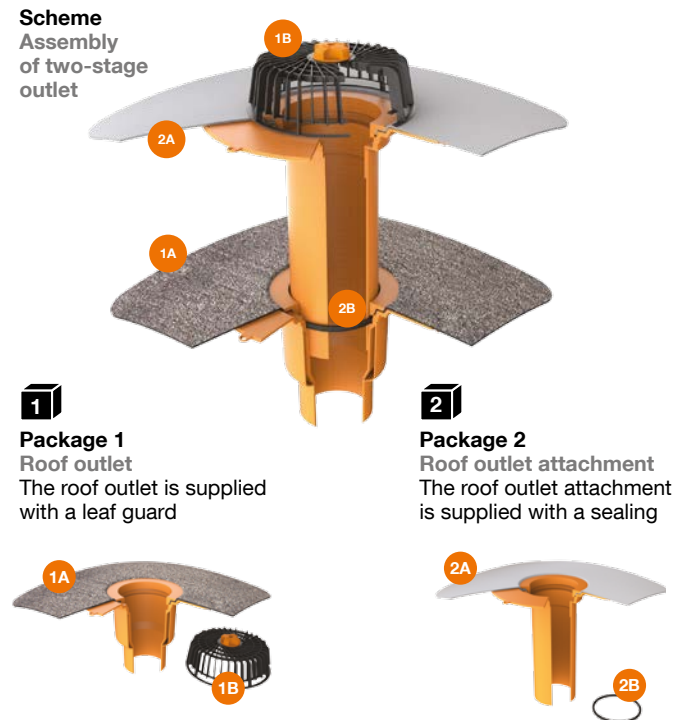

Dimensions of the attachments for roof outlets

Type	for roof outlets TW / TWE	Dimensions [mm]				
		a	b	c	d	Insulation Thickness
TWN v220	75, 110, 125	330	200	290	40	40-220
TWN v300	75, 110, 125	330	200	370	40	40-300
TWN v500	75, 110, 125	330	200	540	40	40-500
TWNE v300	75, 110, 125	330	200	370	100	100-300
TWNE v500	75, 110, 125	330	200	540	100	100-500
TWN v300 XL	160	342	265	330	120	120-300

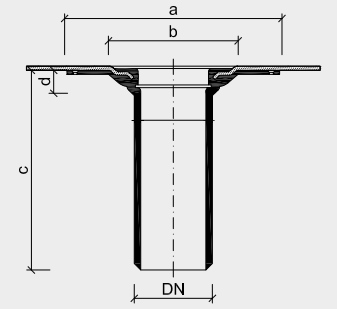

Attachments for thermal insulation for TOPWET roof outlets

Version	Type	Insulation thickness
TOPWET attachment with an integrated flange of modified bitumen for vertical and horizontal TOPWET roof outlets of DN 70, 100 and 125, with a sealing ring, without a leaf guard (XL version only for outlets of DN 150). TWNE = heated performance, suitable for an insulation thickness over 100 mm.	TWN v220 BIT	40-220 mm
	TWN v300 BIT	40-300 mm
	TWN v500 BIT	40-500 mm
	TWNE v300 BIT	100-300 mm
	TWNE v500 BIT	100-500 mm
TOPWET attachment with an integrated PVC membrane waterproofing flange for vertical and horizontal TOPWET roof outlets of DN 70, 100 and 125, with a sealing ring, without a leaf guard (XL version only for outlets of DN 150). TWNE = heated performance, suitable for an insulation thickness over 100 mm.	TWN v300 BIT XL	120-300 mm
	TWN v220 PVC	40-220 mm
	TWN v300 PVC	40-300 mm
	TWN v500 PVC	40-500 mm
	TWNE v300 PVC	100-300 mm
	TWNE v500 PVC	100-500 mm
	TWNE v300 PVC XL	120-300 mm

Option to supply with custom made flange (EPDM, TPO, FPO, PR, STE - suitable for cold liquid applied applications. For more information please see page 9.

Emergency drainage

Accessories	Version	Type	Overflow height
		TWN OVER	40-120 mm

Electronic thermostats to control the heated roof drains TOPWET and heating kit

Accessories	Version	Type	Dimensions
		TWT 524	70x70 mm
		TWT 3528	90x50 mm
		TW SE TW SE XL	

Terrace outlets

Drainage of flat roofs, terraces and balconies

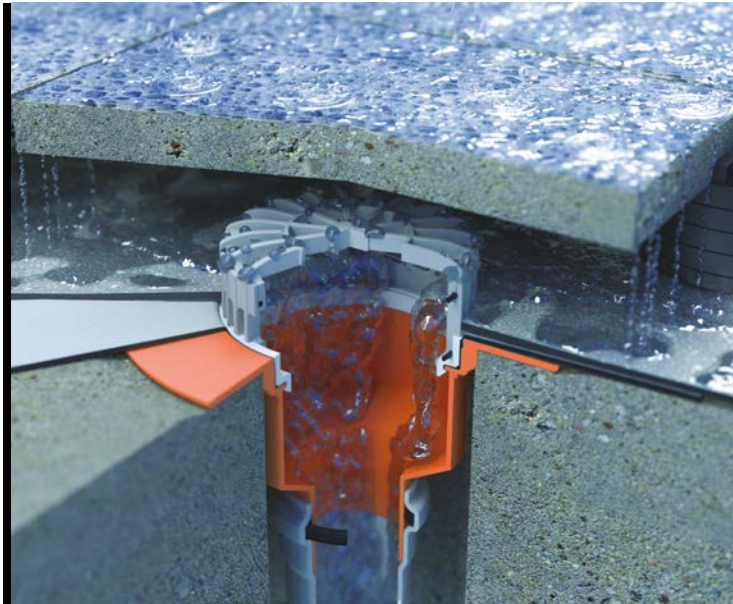

- Vertical or horizontal version DN 50-125
- Higher outlet capacity
- Construction from polyamide PA6
- Integrated sleeve made of a waterproof strip or foil
- Low construction height
- A special low leaf guard is part of every outlet, with possibility of adjustment to a flat basket
- A heated version will ensure reliable drainage even in the winter season

Terrace outlets – vertical version

Type	DN	Dimensions [mm]						
		a	b	c	d	e	f	g
TWT(E) 50 S	50	204	182	47	*85	*50	133	156
TWT(E) 75 S	70	204	182	80	*52	*50	133	156
TWT(E) 110 S	100	204	182	80	*52	*50	133	156
TWT(E) 125 S	125	204	182	80	*52	*50	133	156

Terrace outlets – horizontal version

Type	DN	Dimensions [mm]			
		a	b	c	d
TWT(E) 50 V	50	204	92	225	44
TWT(E) 75 V	70	204	102	225	28
TWT(E) 110 V	100	204	143	238	33
TWT(E) 125 V	125	204	143	238	26

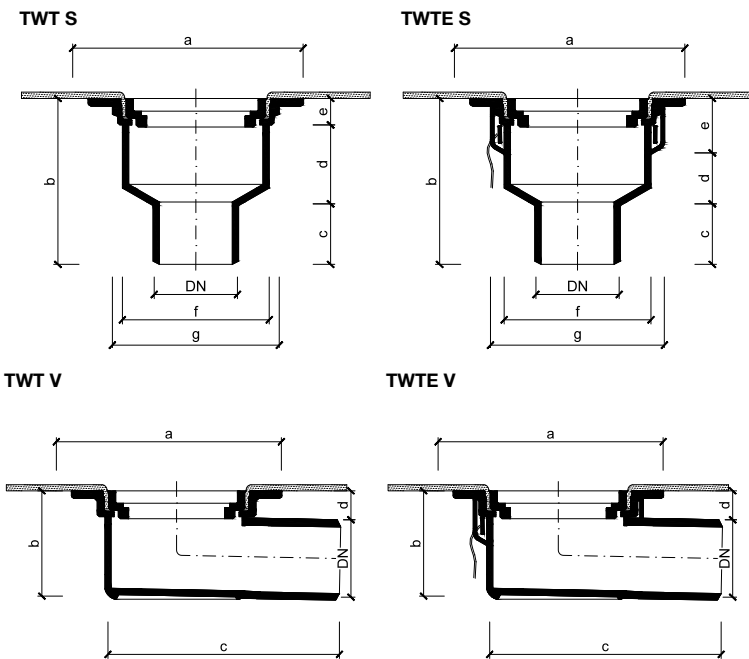

TOPWET terrace outlet with an integrated bitumen sleeve

BIT	Version	Type	Dimensions
	TOPWET terrace outlet with an integrated sleeve from a modified bitumen strip, vertical version, with a leaf guard	TWT 50 BIT S TWT 75 BIT S TWT 110 BIT S TWT 125 BIT S	DN 50 DN 70 DN 100 DN 125
	TOPWET terrace outlet with an integrated sleeve from a modified bitumen strip, vertical version, heated 230 V with a connecting cable, with a leaf guard	TWTE 50 BIT S TWTE 75 BIT S TWTE 110 BIT S TWTE 125 BIT S	DN 50 DN 70 DN 100 DN 125
	TOPWET terrace outlet with an integrated sleeve of a modified bitumen strip, horizontal version, with a leaf guard	TWT 50 BIT V TWT 75 BIT V TWT 110 BIT V TWT 125 BIT V	DN 50 DN 70 DN 100 DN 125
	TOPWET terrace outlet with an integrated sleeve from a modified bitumen strip, horizontal version, heated 230 V with a connecting cable, with a leaf guard	TWTE 50 BIT V TWTE 75 BIT V TWTE 110 BIT V TWTE 125 BIT V	DN 50 DN 70 DN 100 DN 125

Option to supply with custom made sleeve (EPDM, TPO, FPO, PR, STE - suitable for cold liquid applied applications. For more information please see page 9.

TOPWET terrace outlets with an integrated PVC sleeve

PVC	Version	Type	Dimensions
	TOPWET terrace outlets with an integrated PVC sleeve from waterproof membrane based on PVC, vertical version, with a leaf guard	TWT 50 PVC S TWT 75 PVC S TWT 110 PVC S TWT 125 PVC S	DN 50 DN 70 DN 100 DN 125
	TOPWET terrace outlets with an integrated PVC sleeve from waterproof membrane based on PVC, vertical version, heated 230 V with a connecting cable, with a leaf guard	TWTE 50 PVC S TWTE 75 PVC S TWTE 110 PVC S TWTE 125 PVC S	DN 50 DN 70 DN 100 DN 125
	TOPWET terrace outlets with an integrated PVC sleeve of waterproof membrane based on PVC, horizontal version, with a leaf guard	TWT 50 PVC V TWT 75 PVC V TWT 110 PVC V TWT 125 PVC V	DN 50 DN 70 DN 100 DN 125
	TOPWET terrace outlets with an integrated PVC sleeve from waterproof membrane based on PVC, horizontal version, heated 230 V with a connecting cable, with a leaf guard	TWTE 50 PVC V TWTE 75 PVC V TWTE 110 PVC V TWTE 125 PVC V	DN 50 DN 70 DN 100 DN 125

Option to supply with custom made sleeve (EPDM, TPO, FPO, PR, STE - suitable for cold liquid applied applications. For more information please see page 9.

Accessories for roof outlets, terrace outlets and attachments

Drainage of ballast roofs, terraces and balconies and anti-stink measures



Accessories for roof outlets, terrace outlets and attachments

- On roofs with a ballast layer of gravel it is necessary to use a perforated extension chamber
- Wide range of accessories for walkable roofs
- Terrace attachments for drainage from the paving surface level
- Possibility of using an odour trap inserted in the outlet

Leaf guard for roofs with gravel

Type	DN	Dimensions [mm]		Purpose
		a		
TWOK v100	125*	100		A universal basket for roof outlets DN 70, 100 and 125, terrace outlets DN 50, 70, 100 and 125, attachments for outlets, sanitation outlet and extended outlets
TWOK v133	125*	133		
TWOK v166	125*	166		
TWOK v200	125*	200		
TWOK v20-1000 XL	150	20-1000		For roof outlets DN 150 and attachments for XL outlets

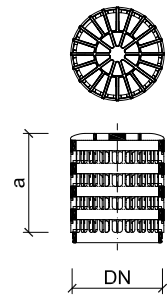

*** How can attachments be universal for various diameters of roof and terrace outlets DN 50, 70, 100 and 125?**

The outlets have a neck or an integrated flange of the same construction and diameter. The outlet construction only differs below the neck. Ensuring that all the accessories are universal.

Terrace attachments

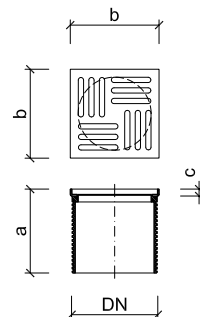

Type	DN	Dimensions [mm]			Purpose
		a	b	c	
TW TER	125*	100	135	11	A universal terrace attachment for roof outlets DN 70, 100 and 125, terrace outlets DN 50, 70, 100 and 125, attachments for outlets, sanitation outlet and extended outlets
TW TER P	125*	220	135	11	
TWNR TER v10-1000 XL(P) (D)	150	10-1000	150	11	For roof outlets DN 150 and attachments for XL outlets



**** What attachment shall I use if I have screed finish which is at the level of the outlet neck?**

For this type of finish, there is TW TER attachment which can be shortened according to the height of the screed and paving.

Mechanical roof flaps into TOPWET roof outlets, terrace outlets and roof outlets attachments

Accessories	Version	Type	Height
	The new generation of mechanical roof flap TOPWET with increased drainage capacity and self-cleaning properties. It is designed for roof drains, attachments and balcony drains TOPWET. The flap can not be used for DN 150 drains and for redevelopment and extended drains. The flap should not be installed in an environment with the inhibited air circulation.	TWZU KL	
	The new generation water odour trap TOPWET with an increased drainage capacity. It is designed for roof drains, attachments and balcony drains TOPWET. The water level of 50 mm. The cap cannot be used for DN 150 drains and for redevelopment and extended drains. The flap is designed for environments with no free air circulation and for places where a possibility of freezing is eliminated.	TWZU	50 mm

Accessories for roof outlets, terrace outlets and roof outlets attachments

Accessories	Version	Type	Height above insulation level
	The new generation terraced attachment TOPWET for balconies and terraces with glued or otherwise mounted finish. The package includes three drainage rings for the more continuous water runoff from the main waterproof system. The terraced attachment can be extended with another drainage ring TW ODK by about 33 mm or the attachment TWN TER. The attachment height is adjustable; the thick-walled polyamide PA6 UV Stabil design.	TW TER	0-100 mm
	The new generation perforated terraced attachment TOPWET for balconies and terraces with the pavement. The package includes three drainage rings for smoother water runoff from the main waterproof system. The terraced attachment can be extended with another drainage ring TW ODK by about 33 mm or the attachment TWN TER. The attachment height is adjustable; the thick-walled polyamide PA6 UV Stabil design.	TW TER P	0-220 mm
	The extended attachment for the extension of the terraced attachment by 120 mm as a maximum. The exact height of the attachment can always be adapted directly on site. The thick-walled polyamide PA6 UV Stabil design.	TWN TER	15-120 mm
	The new generation flat walkable leaf guard TOPWET. The thick-walled polyamide PA6 UV Stabil design. The height above the level of the waterproof system is 10 mm.	TW ODK	+33 mm
	The new generation flat walkable leaf guard TOPWET. The thick-walled polyamide PA6 UV Stabil design. The height above the level of the waterproof system is 10 mm.	TW PLK	+10 mm
	The new generation perforated leaf guard TOPWET for roofs with gravel or other load-increasing strata. The basket can be extended with the drainage ring TW ODK always by 33 mm. The thick-walled polyamide PA6 UV Stabil design. The hole size of 10x15 mm.	TWOK v33 TWOK v66 TWOK v100 TWOK v133 TWOK v166 TWOK v200	33 mm 66 mm 100 mm 133 mm 166 mm 200 mm

Sanitation outlets and vents

Flat roof refurbishment outlets and vents



Basic type – refurbishment outlets with length of 400 mm

- Direct connection to existing roof outlets or vertical downpipes
- Wide assortment of fine graduated diameters
- Easy application with refurbishment with use of a new heat-insulated layer from a thickness of 50 mm
- Custom manufacturing of higher sanitation outlets with a tube of a length up to 2000 mm
- Lip seal against raised water included in each outlet
- Slippery means included in each package
- Heated version on request

Refurbishment outlet for warm roofs

Type	Dimensions [mm]				
	a	b	c**	d	e
TW SAN 50	330	220	400	40 (80°)	90
TW SAN 75	330	220	400	40 (80°)	90
TW SAN 90	330	220	400	40 (75°)	90
TW SAN 104	330	220	400	40 (80°)	90
TW SAN 110	330	220	400	40 (80°)	90
TW SAN 125	330	220	400	40 (80°)	90
TW SAN 160	342	265	400	40 (90°)	120

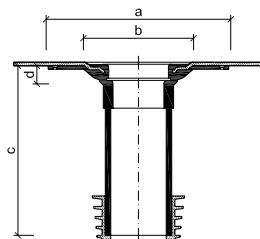

Refurbishment outlet for warm roofs

Type	Dimensions [mm]			
	e	f	g	h
TW SAN BZ 50	250	400	56	60
TW SAN BZ 75	250	400	81	60
TW SAN BZ 90	250	400	96	60
TW SAN BZ 104	250	400	116	60
TW SAN BZ 110	250	400	116	60
TW SAN BZ 125	250	400	131	60

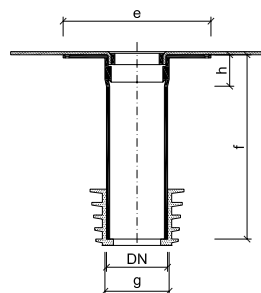

The outlet may be inserted into existing outlet, pipe or gutter up to a neck, but it has lower drain capacity

* dimension at heated version
** optionally extension up to 2000 mm to order (extra charges apply)

Selection table for refurbishment outlets

Type	For connection to piping of diameter	Type of existing downpipe [DN]															
		Cast iron			PE			PVC			PP						
		70	80	100	110	125	150	63	75	90	110	125	150	70	100	125	150
TW SAN 50	54-72 mm	x						x	x					x			
TW SAN 75	79-102 mm		x							x							x
TW SAN 90	99-106 mm			x							x				x		x
TW SAN 104	109-116 mm				x												
TW SAN 110	116-129 mm					x						x					x
TW SAN 125	144-154 mm						x						x		x		x

TOPWET sanitation outlets with integrated bitumen sleeve

BIT	Version	Type	For connection to piping of diameter
	TOPWET sanitation outlet with an integrated sleeve of a modified bitumen strip with a leaf guard. Length 400 mm, option of extension up to 2000 mm on request.	TW SAN 50 BIT TW SAN 75 BIT TW SAN 90 BIT TW SAN 104 BIT TW SAN 110 BIT TW SAN 125 BIT TW SAN 160 BIT XL	54-72 mm 79-102 mm 99-106 mm 109-116 mm 116-129 mm 144-154 mm 186-200 mm
	TOPWET sanitation outlet with an integrated sleeve of a modified bitumen strip with a leaf guard, heated with 230 V with a supply cable. Length 400 mm, option of extension up to 2000 mm on request.	TWE SAN 50 BIT TWE SAN 75 BIT TWE SAN 90 BIT TWE SAN 104 BIT TWE SAN 110 BIT TWE SAN 125 BIT TWE SAN 160 BIT XL	54-72 mm 79-102 mm 99-106 mm 109-116 mm 116-129 mm 144-154 mm 186-200 mm
	TOPWET sanitation outlet for cold roofs with an integrated sleeve of a modified bitumen strip with a leaf guard. The outlet may be inserted into redeveloped pipes up to a neck, but it has lower drain capacity. Length 400 mm, option of extension up to 1000 mm on request.	TW SAN BZ 50 BIT TW SAN BZ 75 BIT TW SAN BZ 90 BIT TW SAN BZ 104 BIT TW SAN BZ 110 BIT TW SAN BZ 125 BIT	54-72 mm 79-102 mm 99-106 mm 109-116 mm 116-129 mm 144-154 mm
	TOPWET sanitation vent determined for connection to sewerage ventilation piping with an integrated sleeve of a modified bitumen strip including a rain cap. A height above insulation of 300 mm, a height below insulation of 200 mm, option of extension up to 2000 mm on request.	TWOP SAN 50 BIT TWOP SAN 75 BIT TWOP SAN 90 BIT TWOP SAN 110 BIT TWOP SAN 125 BIT	54-72 mm 79-102 mm 99-106 mm 116-129 mm 144-154 mm

Option to supply with custom made sleeve (EPDM, TPO, FPO, PR, STE - suitable for cold liquid applied applications. For more information please see page 9.

TOPWET sanitation outlets with integrated PVC sleeve

PVC	Version	Type	For connection to piping of diameter
	TOPWET sanitation outlet with an integrated sleeve of PVC membrane with a leaf guard. Length 400 mm, option of extension up to 2000 mm on request.	TW SAN 50 PVC TW SAN 75 PVC TW SAN 90 PVC TW SAN 104 PVC TW SAN 110 PVC TW SAN 125 PVC TW SAN 160 PVC XL	54-72 mm 79-102 mm 99-106 mm 109-116 mm 116-129 mm 144-154 mm 186-200 mm
	TOPWET sanitation outlet with an integrated sleeve of PVC membrane with a leaf guard, heated with 230 V with a supply cable. Length 400 mm, option of extension up to 2000 mm on request.	TWE SAN 50 PVC TWE SAN 75 PVC TWE SAN 90 PVC TWE SAN 104 PVC TWE SAN 110 PVC TWE SAN 125 PVC TWE SAN 160 PVC XL	54-72 mm 79-102 mm 99-106 mm 109-116 mm 116-129 mm 144-154 mm 186-200 mm
	TOPWET sanitation outlet for cold roofs with an integrated sleeve of PVC membrane with a leaf guard. The outlet may be inserted into redeveloped pipes up to a neck, but it has lower drain capacity. Length 400 mm, option of extension up to 1000 mm on request.	TW SAN BZ 50 PVC TW SAN BZ 75 PVC TW SAN BZ 90 PVC TW SAN BZ 104 PVC TW SAN BZ 110 PVC TW SAN BZ 125 PVC	54-72 mm 79-102 mm 99-106 mm 109-116 mm 116-129 mm 144-154 mm
	TOPWET sanitation vent for connection to sewerage ventilation piping with an integrated sleeve of a waterproof membrane based on PVC including a rain cap. A height above insulation of 300 mm, a height below insulation of 200 mm, option of extension up to 2000 mm on request.	TWOP SAN 50 PVC TWOP SAN 75 PVC TWOP SAN 90 PVC TWOP SAN 110 PVC TWOP SAN 125 PVC	54-72 mm 79-102 mm 99-106 mm 116-129 mm 144-154 mm

Option to supply with custom made sleeve (EPDM, TPO, FPO, PR, STE - suitable for cold liquid applied applications. For more information please see page 9.

Extended single-wall roof outlets

Drainage of flat roofs



- Standard length 400 mm
- Length up to 2000 mm on request
- Option of length modification directly on construction site
- Simple assembly

On request

- Option for heated version

Technical information

- Number of combinations with outlet attachments and mechanical roof flaps
- It is possible to combine with TWOK and TW TER accessories

Extended single-wall roof outlets

Type	DN	Dimensions [mm]					
		a	b**	c	d	e	f
TWJ 50	50	330	400	40 (80°)	90	200	160
TWJ 75	70	330	400	40 (80°)	90	200	160
TWJ 90	90	330	400	40 (80°)	90	200	160
TWJ 110	100	330	400	40 (80°)	90	200	160
TWJ 125	125	330	400	40 (80°)	90	200	160
TWJ 160	150	342	400	40 (90°)	120	265	205

* dimension at heated version
 ** optionally extension up to 2000 mm to order

Extended single-wall roof outlets Roofs without thermal insulation

Type	DN	Dimensions [mm]			
		g	h	i	k
TWJ BZ 50	50	250	400	56	60
TWJ BZ 75	70	250	400	81	60
TWJ BZ 90	90	250	400	96	60
TWJ BZ 110	100	250	400	116	60
TWJ BZ 125	125	250	400	131	60

The outlet may be inserted into existing outlet, pipe or gutter up to a neck, but it has lower drain capacity

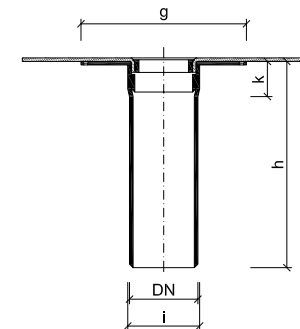
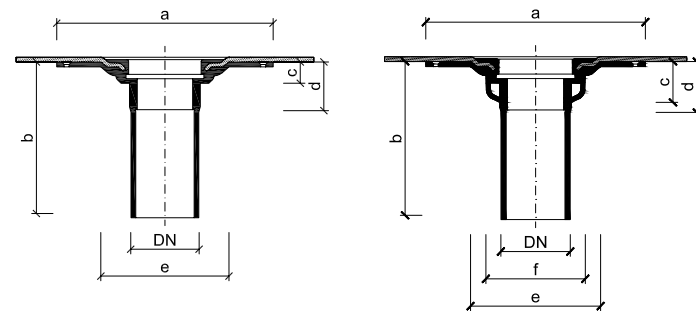

What is the difference between the standard outlet and the BZ outlet?
 Outlets with BZ marking (without thermal insulation) are useful for uninsulated structures, gutters or redevelopments when it is necessary to insert the outlet into the pipe or the hole up to the neck. In contrast to the standard version the BZ outlets have lower drain capacity.

Extended single-wall roof outlets with integrated bitumen sleeve

BIT	Version	Type	DN / Outlet length
	TOPWET roof outlet with an integrated sleeve of a modified bitumen strip with a leaf guard. Single-wall, length option on request.	TWJ 50 BIT TWJ 75 BIT TWJ 90 BIT TWJ 110 BIT TWJ 125 BIT TWJ 160 BIT XL	DN 50 / 400 mm DN 70 / 400 mm DN 90 / 400 mm DN 100 / 400 mm DN 125 / 400 mm DN 150 / 400 mm
	TOPWET roof outlet with an integrated sleeve of a modified bitumen strip with a leaf guard, heated with 230 V with a supply cable 1.5 m. Single-wall, length option on request.	TWJE 50 BIT TWJE 75 BIT TWJE 90 BIT TWJE 110 BIT TWJE 125 BIT TWJE 160 BIT XL	DN 50 / 400 mm DN 70 / 400 mm DN 90 / 400 mm DN 100 / 400 mm DN 125 / 400 mm DN 150 / 400 mm
	TOPWET roof outlet cold roofs with an integrated sleeve of a modified bitumen strip with a leaf guard. The outlet may be inserted into redeveloped pipes up to a neck, but it has lower drain capacity. Length 400 mm, option of extension up to 1000 mm on request.	TWJ BZ 50 BIT TWJ BZ 75 BIT TWJ BZ 90 BIT TWJ BZ 110 BIT TWJ BZ 125 BIT	DN 50 / 400 mm DN 70 / 400 mm DN 90 / 400 mm DN 100 / 400 mm DN 125 / 400 mm
	TOPWET roof outlet for cold roofs with an integrated sleeve from a modified bitumen sheet with a leaf guard. The outlet can be inserted in a pipe or opening up to the neck but it has a lower outlet capacity. 400 mm long, to order it can be extended to 600 mm.	TWJ NR 50 BIT TWJ NR 75 BIT TWJ NR 90 BIT TWJ NR 110 BIT TWJ NR 125 BIT	DN 50 / 400 mm DN 70 / 400 mm DN 90 / 400 mm DN 100 / 400 mm DN 125 / 400 mm

Option to supply with custom made sleeve (EPDM, TPO, FPO, PR, STE - suitable for cold liquid applied applications. For more information please see page 9.

Extended single-wall roof outlets with integrated PVC sleeve

PVC	Version	Type	DN / Outlet length
	TOPWET roof outlet with an integrated sleeve of a waterproof membrane based on PVC with a leaf guard. Single-wall, length option on request.	TWJ 50 PVC TWJ 75 PVC TWJ 90 PVC TWJ 110 PVC TWJ 125 PVC TWJ 160 PVC XL	DN 50 / 400 mm DN 70 / 400 mm DN 90 / 400 mm DN 100 / 400 mm DN 125 / 400 mm DN 150 / 400 mm
	TOPWET roof outlet with an integrated sleeve of a waterproof membrane based on PVC with a leaf guard, heated with 230 V with a supply cable 1.5 m. Single-wall, length option on request.	TWJE 50 PVC TWJE 75 PVC TWJE 90 PVC TWJE 110 PVC TWJE 125 PVC TWJE 160 PVC XL	DN 50 / 400 mm DN 70 / 400 mm DN 90 / 400 mm DN 100 / 400 mm DN 125 / 400 mm DN 150 / 400 mm
	TOPWET roof outlet for cold roofs with an integrated sleeve of a waterproof membrane based on PVC with a leaf guard. The outlet may be inserted into redeveloped pipes up to a neck, but it has lower drain capacity. Length 400 mm, option of extension up to 1000 mm on request.	TWJ BZ 50 PVC TWJ BZ 75 PVC TWJ BZ 90 PVC TWJ BZ 110 PVC TWJ BZ 125 PVC	DN 50 / 400 mm DN 70 / 400 mm DN 90 / 400 mm DN 100 / 400 mm DN 125 / 400 mm
	TOPWET roof outlet cold roofs with an integrated sleeve from PVC based hydro-insulation foil with a leaf guard. The outlet can be inserted in a pipe or opening up to the neck but it has a lower outlet capacity. 400 mm long, to order it can be extended to 600 mm.	TWJ NR 50 PVC TWJ NR 75 PVC TWJ NR 90 PVC TWJ NR 110 PVC TWJ NR 125 PVC	DN 50 / 400 mm DN 70 / 400 mm DN 90 / 400 mm DN 100 / 400 mm DN 125 / 400 mm

Option to supply with custom made sleeve (EPDM, TPO, FPO, PR, STE - suitable for cold liquid applied applications. For more information please see page 9.

Balcony outlets

Drainage of balconies



- DN 70 vertical and horizontal version
- PA6 polyamide construction
- Integrated sleeve of waterproof strip or foil
- Low construction height
- Suitable to drain smaller areas
- Protective and removable grid included in each outlet
- Heated version ensures reliable draining even in winter season

Balcony outlets – vertical version

Type	DN	Dimensions [mm]							
		a	b	c	d	e	f	g	h
TWB 50 S	50	150	116	47	43	26	105	-	-
TWB 75 S	70	150	120	50	49	21	95	-	-
TWBE 50 S	50	150	116	47	-	-	105	43	26
TWBE 75 S	70	150	120	50	-	-	95	49	21

Balcony outlets – horizontal version

Type	DN	Dimensions [mm]			
		a	b	c	d
TWB 50 V	50	160	64	175	14
TWB 75 V	70	150	96	163	21
TWBE 50 V	50	160	64	175	14
TWBE 75 V	70	150	96	163	21

TWB S

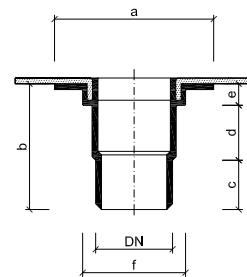

TWBE S

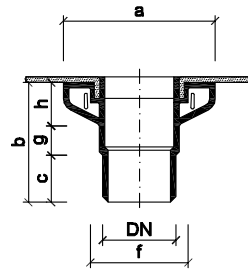

TWB V

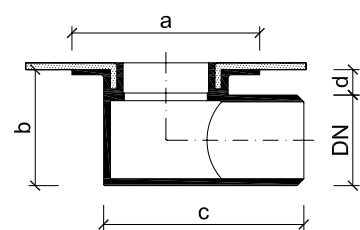

TWBE V

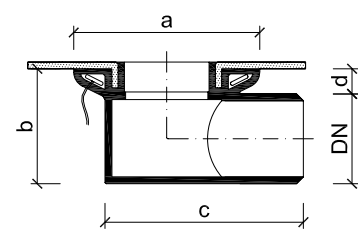

TOPWET balcony outlets with integrated bitumen sleeve

BIT	Version	Type	Dimensions
	TOPWET balcony outlet with an integrated sleeve of a modified bitumen strip, vertical version, with a leaf guard.	TWB 50 BIT S TWB 75 BIT S	DN 50 DN 70
	TOPWET balcony outlet with an integrated sleeve of a modified bitumen strip, vertical version, heated with 230 V with a supply cable, with a leaf guard.	TWBE 50 BIT S TWBE 75 BIT S	DN 50 DN 70
	TOPWET balcony outlet with an integrated sleeve of a modified bitumen strip, horizontal version, with a leaf guard.	TWB 50 BIT V TWB 75 BIT V	DN 50 DN 70
	TOPWET balcony outlet with an integrated sleeve of a modified bitumen strip, horizontal version, heated with 230 V with a supply cable, with a leaf guard.	TWBE 50 BIT V TWBE 75 BIT V	DN 50 DN 70

Option to supply with custom made sleeve (EPDM, TPO, FPO, PR, STE - suitable for cold liquid applied applications. For more information please see page 9.





TOPWET balcony outlets with integrated PVC sleeve

PVC	Version	Type	Dimensions
	TOPWET balcony outlet with an integrated sleeve of a waterproof membrane based on PVC, vertical version, with a leaf guard.	TWB 50 PVC S TWB 75 PVC S	DN 50 DN 70
	TOPWET balcony outlet with an integrated sleeve of a waterproof membrane based on PVC, vertical version, heated with 230 V with a supply cable, with a leaf guard.	TWBE 50 PVC S TWBE 75 PVC S	DN 50 DN 70
	TOPWET balcony outlet with an integrated sleeve of a waterproof membrane based on PVC, horizontal version, with a leaf guard.	TWB 50 PVC V TWB 75 PVC V	DN 50 DN 70
	TOPWET balcony outlet with an integrated sleeve of a waterproof membrane based on PVC, horizontal version, heated with 230 V with a supply cable, with a leaf guard.	TWBE 50 PVC V TWBE 75 PVC V	DN 50 DN 70

Option to supply with custom made sleeve (EPDM, TPO, FPO, PR, STE - suitable for cold liquid applied applications. For more information please see page 9.

Accessories for TOPWET balcony outlets

Accessories for TOPWET balcony outlets

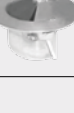
Version	Type	Height above insulation level
 <p>TOPWET perforated stainless steel leaf guard, for vertical or horizontal version of TOPWET TWB balcony outlets</p>	<p>TWOK BAL v100 TWOK BAL v150 TWOK v ___ BAL</p>	<p>100 mm 150 mm 20-1000 mm</p>
 <p>TOPWET balcony stainless steel attachment with a chrome grid 100x100x10 mm, for vertical or horizontal version of TOPWET TWB balcony outlets</p>	<p>TWNR BAL v50 TWNR BAL v100 TWNR BAL v150 TWNR v ___ BAL</p>	<p>10-50 mm 32-100 mm 32-150 mm 10-1000 mm</p>
 <p>TOPWET partially perforated balcony stainless steel attachment with a chrome grid 100x100x10 mm, for vertical or horizontal version of TOPWET TWB balcony outlets</p>	<p>TWNR BAL v100 D TWNR BAL v150 D TWNR v ___ BAL D</p>	<p>45-100 mm 45-150 mm 10-1000 mm</p>
 <p>TOPWET perforated balcony stainless steel attachment with a chrome grid 100x100x10 mm, for vertical or horizontal version of TOPWET TWB balcony outlets</p>	<p>TWNR BAL v50 P TWNR BAL v100 P TWNR BAL v150 P TWNR BAL v ___ P</p>	<p>10-50 mm 45-100 mm 45-150 mm 10-1000 mm</p>
 <p>Mechanical stainless steel sink trap for vertical and horizontal version of TOPWET TWB balcony outlets</p>	<p>TWZU BAL</p>	

TOPWET balcony floor outlets

Type	DN	Dimensions [mm]					
		a	b	c	d	e	f
TWBP 50 S*	50	160	15	65	45	104	-
TWBP 50 V*	50	160	15	65	-	-	120

* TOPWET balcony floor outlet with an integrated STE sleeve for connecting waterproof screed e.g. sand, cement, filler and special additives, with waterproof ceramic tiles whose surface is drained through the grid of the attachment. The outlet cannot be used for other purposes as it does not permit draining of the drainage layer or surface of the waterproofing layer.

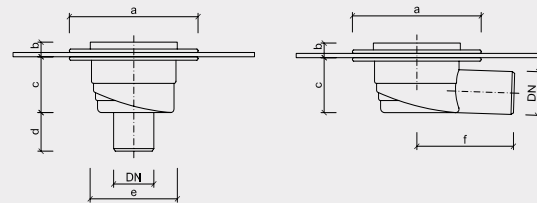

TOPWET balcony floor outlets

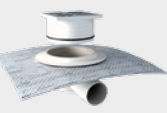
Version	Type	Dimensions
 <p>TOPWET balcony floor outlet with an integrated sleeve for waterproof screed, horizontal and vertical version, including a dry sink trap, plastic attachment and stainless steel grid. Water is not drained from the waterproof layer but only through the stainless steel grid.</p>	<p>TWBP 50 STE S TWBP 50 ___ S TWBP 50 STE V TWBP 50 ___ V</p>	<p>DN 50 DN 50 DN 50 DN 50</p>

Option to supply with custom made sleeve (EPDM, TPO, FPO, PR, STE - suitable for cold liquid applied applications. For more information please see page 9.



Inspection chamber for Green Roofs

Accessories for roofs with vegetation layers

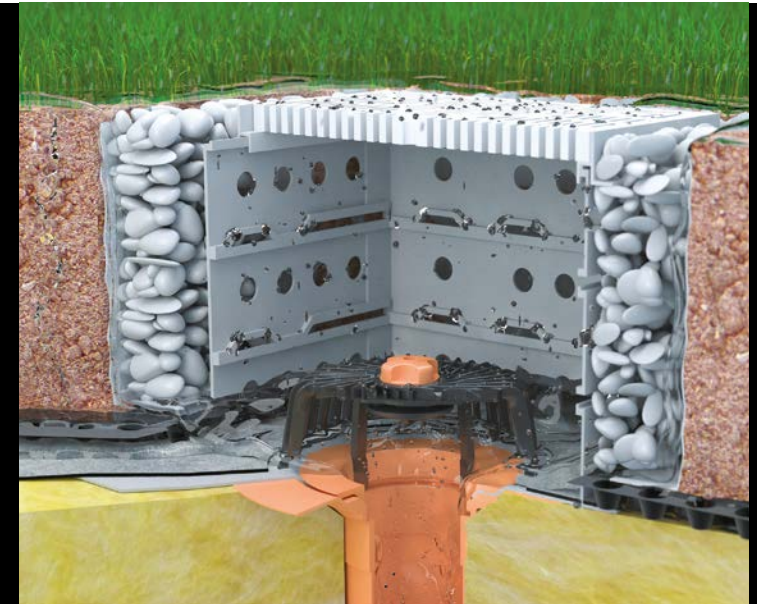
- New inspection chamber construction of polyamide in neutral grey shade
- Hard, UV stable and weather resistant material
- Optimized holes for water drain from green roof layers
- New removable cover of massive polypropylene in a robust frame
- Two square plan basic sizes, width 300 or 400 mm
- Variable assembly arrangement in relation to the height of vegetation layers
- Ideal access for inspection and cleaning of roof outlets



Inspection chamber for Green Roofs

Version	Type	Dimensions
 <p>Inspection chamber for green roofs, height 130 mm, including plastic cover grid</p>	<p>TWZ 300x300x130 TWZ 400x400x130</p>	<p>300x300 mm 400x400 mm</p>
 <p>Inspection chamber for green roofs, height 230 mm, including plastic cover grid</p>	<p>TWZ 300x300x230 TWZ 400x400x230</p>	<p>300x300 mm 400x400 mm</p>
 <p>Inspection chamber for green roofs, height 330 mm, including plastic cover grid</p>	<p>TWZ 300x300x330 TWZ 400x400x330</p>	<p>300x300 mm 400x400 mm</p>
 <p>Inspection chamber for green roofs, height on request, including plastic cover grid</p>	<p>TWZ 300x300x ___ TWZ 400x400x ___</p>	<p>300x300 mm 400x400 mm</p>

Through wall outlets and safety overflows

Drainage of flat roofs, terraces and balconies

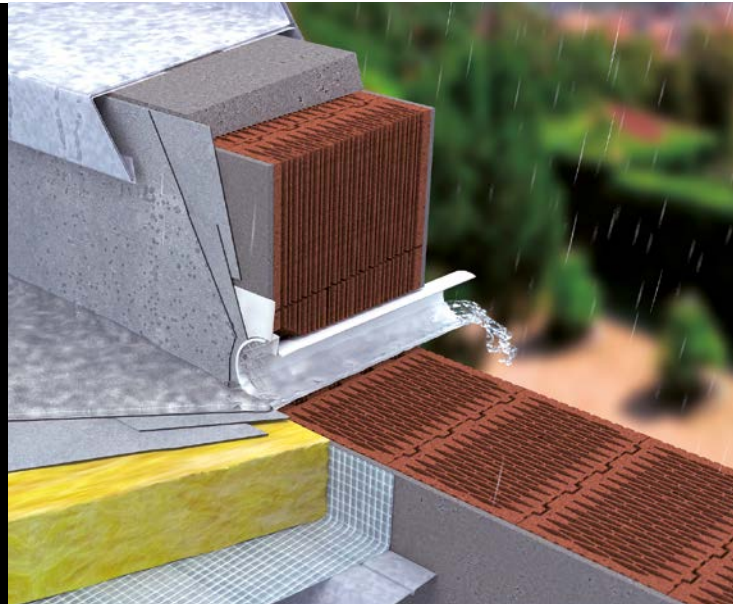

Basic type – round through wall outlet of 500 mm length

- New design with a lowered drain edge
- Integrated sleeve of waterproofing membrane
- Protective and removable grid included in each through wall outlet
- Possibility to extend up to 2000 mm
- Through wall outlet body made of PA 6 polyamide, piping made of UV stable PVC
- Heated version ensures reliable drainage even in winter season
- Possibility of connection to a rain hopper or to downpipes DN 50, DN 70, DN 100 a DN 125

Complementary type – mini through wall outlet of 200 mm length

- For drainage of small terraces and balconies
- Low construction height 60 mm
- Special sleeve for connection to trowelled insulation

Through wall outlets – round

Type	DN	Dimesions [mm]							
		a*	b	c	d	e	f	g	h
TWC(E) 50	50	500	20	104	88	13	20	22	44
TWC(E) 75	70	500	20	104	88	13	20	22	44
TWC(E) 110	100	500	20	180	157	13	20	22	44
TWC(E) 125	125	500	20	180	157	13	20	22	44
TWC(E) 160	150	500	20	180	157	13	20	22	44

Safety overflows – round

Type	DN	Dimesions [mm]				
		a*	b	c	d	e
TWPP 50	50	500	20	56	30	97
TWPP 75	70	500	20	81	30	84
TWPP 110	100	500	20	116	30	67
TWPP 125	125	500	20	131	30	59

* Option for extension up to 2000mm subject to special order and additional costs.

TWC

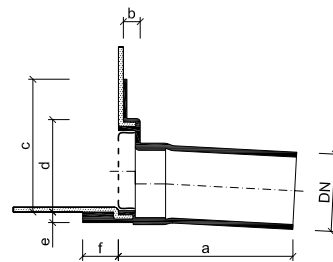

TWCE

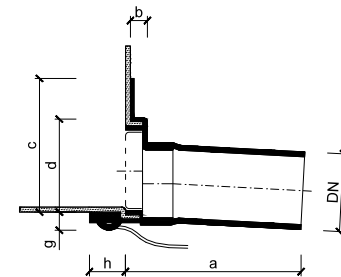

TWPP

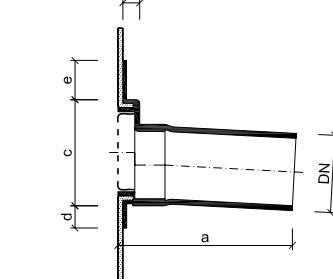

TOPWET through wall outlets and safety overflows with integrated bitumen sleeve

BIT	Version	Type	Dimensions
	TOPWET round through wall outlet with an integrated sleeve of a modified bitumen strip and with a leaf guard. Length 500 mm, option of extension up to 2000 mm on request.	TWC 50 BIT	DN 50
		TWC 75 BIT	DN 70
		TWC 110 BIT	DN 100
		TWC 125 BIT	DN 125
		TWC 160 BIT	DN 150
	TOPWET round through wall outlet with an integrated sleeve of a modified bitumen strip and with a leaf guard, heated with 230 V with a supply cable. Length 500 mm, option of extension up to 2000 mm on request.	TWCE 50 BIT	DN 50
		TWCE 75 BIT	DN 70
		TWCE 110 BIT	DN 100
		TWCE 125 BIT	DN 125
		TWCE 160 BIT	DN 150
	TOPWET round safety overflow with an integrated sleeve of a modified bitumen strip and with a leaf guard. Length 500 mm, option of extension up to 2000 mm on request.	TWPP 50 BIT	DN 50
		TWPP 75 BIT	DN 70
		TWPP 110 BIT	DN 100
		TWPP 125 BIT	DN 125

Option to supply with custom made sleeve (EPDM, TPO, FPO, PR, STE - suitable for cold liquid applied applications. For more information please see page 9.

TOPWET through wall outlets and safety overflows with integrated PVC sleeve

PVC	Version	Type	Dimensions
	TOPWET round gutter spout with an integrated sleeve of PVC membrane and with a leaf guard. Length 500 mm, option of extension up to 2000 mm on request.	TWC 50 PVC	DN 50
		TWC 75 PVC	DN 70
		TWC 110 PVC	DN 100
		TWC 125 PVC	DN 125
		TWC 160 PVC	DN 150
	TOPWET round through wall outlet with an integrated sleeve of a PVC membrane and with a leaf guard, heated with 230 V with a supply cable. Length 500 mm, option of extension up to 2000 mm on request.	TWCE 50 PVC	DN 50
		TWCE 75 PVC	DN 70
		TWCE 110 PVC	DN 100
		TWCE 125 PVC	DN 125
		TWCE 160 PVC	DN 150
	TOPWET round safety overflow with an integrated sleeve of PVC membrane and with a leaf guard. Length 500 mm, option of extension up to 2000 mm on request.	TWPP 50 PVC	DN 50
		TWPP 75 PVC	DN 70
		TWPP 110 PVC	DN 100
		TWPP 125 PVC	DN 125

Option to supply with custom made sleeve (EPDM, TPO, FPO, PR, STE - suitable for cold liquid applied applications. For more information please see page 9.

Stainless steel shaft

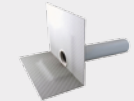

Accessories	Version	Type	Height above insulation level
	Stainless steel shaft for TOPWET through wall outlets and safety overflows for roofs with ballast.	TWS C 250x150x100	100 mm
		TWS C 250x150x200	200 mm

TOPWET MINI through wall outlet – new design of PA 6 polyamide / PVC – lowered drain level

Version	Type	Dimensions
 <p>TOPWET MINI through wall outlet. Length 200 mm, option of extension up to 1500 mm on request. STE – for cold liquid applied waterproofing</p>	TWC 40 BIT MINI	DN 40
	TWC 40 PVC MINI	DN 40
	TWC 40 STE MINI	DN 40

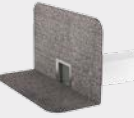

Extension on request is charged.

TOPWET squared through wall outlets and safety overflows with integrated bitumen sleeve

BIT	Version	Type	Dimensions (Height / Width)
 <p>TOPWET squared through wall outlet with an integrated sleeve of a modified bitumen strip. Outlet spout material is PVC, white colour. Length 500 mm, option of extension up to 800 mm on request.</p>	TWC 50x100 BIT	50/100	
	TWC 50x150 BIT	50/150	
	TWC 100x100 BIT	100/100	
	TWC 150x150 BIT	150/150	
	TWC 100x300 BIT	100/300	
 <p>TOPWET squared safety overflow with an integrated sleeve of a modified bitumen strip. Outlet spout material is PVC, white colour. Length 300 mm, option of extension up to 800 mm on request.</p>	TWPP 50x100 BIT	50/100	
	TWPP 50x150 BIT	50/150	
	TWPP 100x100 BIT	100/100	
	TWPP 150x150 BIT	150/150	
	TWPP 100x300 BIT	100/300	



Option to supply with custom made sleeve (EPDM, TPO, FPO, PR, STE - suitable for cold liquid applied applications. For more information please see page 9.

TOPWET squared through wall outlets and safety overflows with integrated PVC sleeve

PVC	Version	Type	Dimensions (Height / Width)
 <p>TOPWET squared through wall outlet with an integrated sleeve of a waterproof membrane based on PVC. Outlet spout material is PVC, white colour. Length 500 mm, option of extension up to 800 mm on request.</p>	TWC 50x100 PVC	50/100	
	TWC 50x150 PVC	50/150	
	TWC 100x100 PVC	100/100	
	TWC 150x150 PVC	150/150	
	TWC 100x300 PVC	100/300	
 <p>TOPWET squared safety overflow with an integrated sleeve of a waterproof membrane based on PVC. Outlet spout material is PVC, white colour. Length 300 mm, option of extension up to 800 mm on request.</p>	TWPP 50x100 PVC	50/100	
	TWPP 50x150 PVC	50/150	
	TWPP 100x100 PVC	100/100	
	TWPP 150x150 PVC	150/150	
	TWPP 100x300 PVC	100/300	

Option to supply with custom made sleeve (EPDM, TPO, FPO, PR, STE - suitable for cold liquid applied applications. For more information please see page 9.

TOPWET through wall outlets for connection to plastic and stainless steel pipes or elbows

Version	Type	Dimensions
 <p>TOPWET round through wall outlet with an integrated sleeve of a modified bitumen strip and with a leaf guard. The through wall outlet is supplied without spout for direct connection to KG & HT rain water pipes and to stainless steel pipes with sealing neck.</p>	TWC 50 BIT x0	DN 50
	TWC 75 BIT x0	DN 70
	TWC 110 BIT x0	DN 100
	TWC 125 BIT x0	DN 125
 <p>TOPWET round through wall outlet with an integrated sleeve of a hydroinsulation foil based on PVC and with a leaf guard. The through wall outlet is supplied without spout for direct connection to KG & HT rain water pipes and to stainless steel pipes with sealing neck.</p>	TWC 50 PVC x0	DN 50
	TWC 75 PVC x0	DN 70
	TWC 110 PVC x0	DN 100
	TWC 125 PVC x0	DN 125

Option to supply with custom made sleeve (EPDM, TPO, FPO, PR, STE - suitable for cold liquid applied applications. For more information please see page 9.
Heated version (TWCE) available on request.

Solutions for multi storey car parks – traverse outlets

Drainage of car parks and traverse areas

Traverse outlets and attachments





- Made of stainless steel
- Extreme mechanical resistance against damage
- Can be supplied in a heated version, see page 11

Traverse grates

- Divided according to the permitted load: up to 1.5 t and up to 12 t
- Removable grate for easy cleaning and inspection



Solutions for multi storey car parks – traverse outlets

Accessories	Version	Type	Dimensions
	Traverse grate for traverse outlets and attachments Version up to 1.5 t and up to 12 t.	TW ROST 110	Do 1,5t
		TW ROST 110 12T	Do 12t
		TW ROST 125	Do 1,5t
		TW ROST 125 12T	Do 12t
	Drainage ring for drainage layers in traverse roofs.	TW ODK POJEZD 110	DN 100
		TW ODK POJEZD 125	DN 125
	Attachment for the traverse gate for car parks, traverse areas, garages and multi-storey car parks. The attachment is made of stainless steel.	TWN POJEZD 110	DN 100
		TWN POJEZD 125	DN 125
	Traverse outlet for car parks, traverse areas, garages and multi-storey car parks. The outlet is made of stainless steel.	TW POJEZD 110	DN 100
		TW POJEZD 125	DN 125
	Transitional part for connecting the traverse outlet to a KG/HT pipe.	TW TRANS 110	DN 100
		TW TRANS 125	DN 125

Sealing sleeves – shaped pieces for waterproofing penetrations through PVC membranes

System solution for penetration of hydro-insulation layer

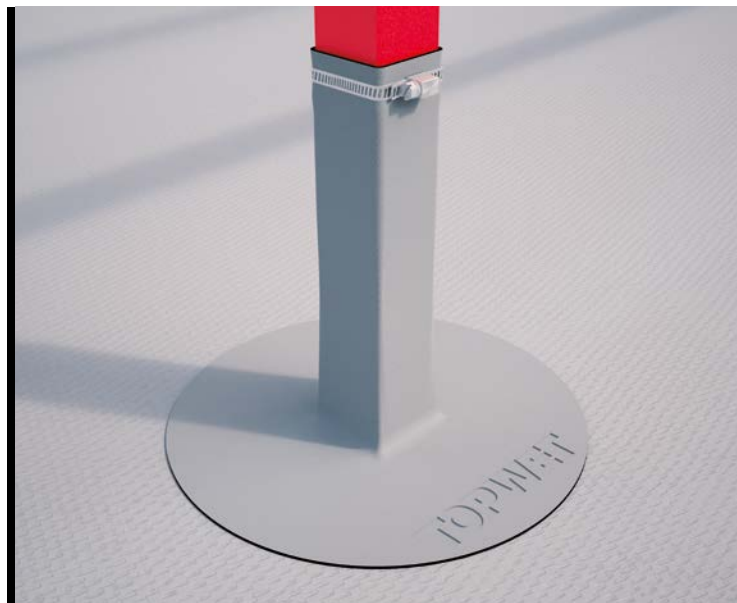

Shaped pieces

- Designed for round and square penetrations
- Wide range of dimensions
- Open design for penetrations without a put on possibility
- Height of all shaped pieces 150 mm
- System treatment of penetrations

Draw bands completely made of stainless steel

- Designed for highly corrosive environment
- Endless band enables production of clamps of any diameter

Sealing sleeves – shaped pieces for waterproofing penetrations of PVC membranes

Type = Dimensions „a“ [mm]	Dimensions [mm]	
	c**	d***
TWUT a TWOT 11*, 12*, 14*, 15, 16, 17, 20, 24, 25, 30, 32, 35	150	150
TWUT a TWOT 40, 42, 43, 45, 50, 51, 56, 60, 65	150	150
TWUT a TWOT 72, 75, 77, 80, 83	150	180
TWUT a TWOT 90, 100, 102, 105, 110, 114	150	250
TWUT a TWOT 120, 125, 138, 140, 150, 160, 170, 180	150	275
TWUT a TWOT 200	150	350

Type = Dimensions „a“ x „b“ [mm]	Dimensions [mm]	
	c**	d***
TWUT a TWOT 8x40*, 8x50*, 8x80, 10x30, 10x40, 10x50, 15x35, 16x16	150	150
TWUT a TWOT 10x35, 20x20, 20x35, 20x40, 25x25, 25x30, 30x30	150	150
TWUT a TWOT 10x60, 15x50, 15x60, 20x50, 20x70, 25x45, 25x50, 27x40	150	150
TWUT a TWOT 30x40, 30x50, 30x60, 35x35, 35x50, 35x70	150	150
TWUT a TWOT 40x40, 40x50, 40x55, 40x60, 40x70	150	150
TWUT a TWOT 50x50, 60x60, 10x90	150	150
TWUT a TWOT 10x100, 15x100, 40x80, 50x80, 55x85, 70x70, 80x80	150	150
TWUT a TWOT 50x100, 60x100, 60x120, 80x160	150	180
TWUT a TWOT 50x150, 75x145, 100x100, 100x150, 120x120, 120x140	150	275
TWUT a TWOT 150x150	150	350

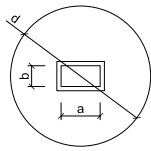
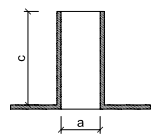
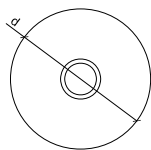
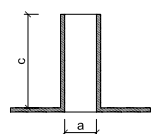

* only closed sealing sleeves ** on request can be delivered at a height of 300 mm
 *** on request can be delivered in diameters up to 350 mm

Sealing sleeves – shaped pieces for waterproofing penetrations through PVC membranes

Accessories	Version	Type (inner diameter / dimensions in mm)	Packaging
	Closed round pipe penetration. Manufactured from 1.5mm mPVC membrane. Type indicates internal diameter in mm. The height of the upstand is 150mm. Colour light grey (RAL 7047).	TWUT 11, 12, 14, 15, 16, 17, 20, 24, 25, 30	5 pcs
		TWUT 32, 35, 40, 42, 43, 45, 50, 51, 56, 60, 65, 70 TWUT 72, 75, 76, 77, 80, 83 TWUT 90, 100, 102, 105, 110 TWUT 114, 120, 125, 138, 140, 150, 160, 170, 180 TWUT 200	5 pcs 5 pcs 5 pcs 5 pcs
	Closed square pipe penetration. Manufactured from 1.5mm mPVC membrane. Type indicates internal diameter in mm. The height of the upstand is 150mm. Colour light grey (RAL 7047).	TWUT 08x35, 08x40, 08x50, 10x30, 10x35, 10x40, 10x50, 10x60, 15x15, 15x35, 15x50, 15x60, 16x16, 20x20, 20x35, 20x40, 20x50, 20x70, 25x25, 25x30, 25x45, 25x50, 27x40, 30x30, 30x40, 30x50, 30x60, 35x35, 35x50, 35x70, 40x40, 40x50, 40x55, 40x60, 40x70, 45x45, 50x50, 60x60	5 pcs
		TWUT 20x70, 35x70, 40x70, 8x80, 10x90, 10x100, 15x100, 40x80, 50x70, 50x80, 55x85, 70x70, 80x80 TWUT 10x120, 15x150, 50x100, 60x100 TWUT 50x150, 60x120, 75x145, 100x100 TWUT 100x150, 120x120, 120x140, 80x160 TWUT 150x150	5 pcs 5 pcs 5 pcs 5 pcs
	Open round pipe penetration. Manufactured from 1.5mm mPVC membrane. Type indicates internal diameter in mm. The height of the upstand is 150mm. Colour light grey (RAL 7047).	TWOT 11, 12, 14, 15, 16, 17, 18, 20, 24, 25, 30 TWOT 32, 35, 40, 42, 43, 45, 50, 51, 56, 60, 65, 70 TWOT 72, 75, 76, 77, 80, 83 TWOT 90, 100, 102, 105, 110 TWOT 114, 120, 125, 138, 140, 150, 160, 170, 180 TWOT 200	5 pcs 5 pcs 5 pcs 5 pcs 5 pcs
		TWOT 08x35, 08x40, 08x50, 10x30, 10x35, 10x40, 10x50, 10x60, 15x15, 15x35, 15x50, 15x60, 16x16, 20x20, 20x35, 20x40, 20x50, 20x70, 25x25, 25x30, 25x45, 25x50, 27x40, 30x30, 30x40, 30x50, 30x60, 35x35, 35x50, 35x70, 40x40, 40x50, 40x55, 40x60, 40x70, 45x45, 50x50, 60x60	5 pcs
	Open square pipe penetration. Manufactured from 1.5mm mPVC membrane. Type indicates internal diameter in mm. The height of the upstand is 150mm. Colour light grey (RAL 7047).	TWOT 20x70, 35x70, 40x70, 8x80, 10x90, 10x100, 15x100, 40x80, 50x70, 50x80, 55x85, 70x70, 80x80 TWOT 10x120, 15x150, 50x100, 60x100 TWOT 50x150, 60x120, 75x145, 100x100 TWOT 100x150, 120x120, 120x140, 80x160 TWOT 150x150	5 pcs 5 pcs 5 pcs 5 pcs
		TWOT 10x120, 15x150, 50x100, 60x100 TWOT 50x150, 60x120, 75x145, 100x100 TWOT 100x150, 120x120, 120x140, 80x160 TWOT 150x150	5 pcs 5 pcs 5 pcs
	Closed round shaped piece of PVC foil designed for treatment of cable penetrations with diameter up to 11 mm. The shaped piece height is 300 mm. Base diameter 150 mm.	TWUT 11/300	5 pcs
	Cone (KUZ) and a bellows (VLN) fittings of homogenous foil based on mPVC. Color: SV – light grey, TM – dark grey	TW KUZ	10 pcs
		TW VLN	10 pcs
	Endless jubilee band completely made of stainless steel with independent lock pieces enable production of jubilee bands of any diameter. Locks packed by 25 pcs. Band length 3 m or 25 m. Material: stainless chromium-nickel steel. The lock pieces have a zinc coated stainless steel screw. Zinc serves as a lubricant, without this the clamp is hard to tighten.	TWSP NEK 3 – band width 8 mm TWSP NEK 25 – band width 8 mm TWSP ZAM – band width 8 mm TWSP NEK 25 s14 – band width 14 mm TWSP ZAM s14 – band width 14 mm	1 pc (3m) 1 pc (25m) 25 pcs 1 pc (25m) 25 pcs

Vents and penetrations

Ventilation of roofs, sewerage and cable penetrations



- Simple construction for effective ventilation of double-skin roofs
- Fixing points for firm attachment to the substrate of the upper coating
- Integrated waterproof sleeve for reliable connection to the roofing
- Completely new products for professional termination of sewerage ventilation piping
- Applicable for all commonly used DN 50, DN 70, DN 100 and DN 125 ventilation piping
- Base plate enables air-tight penetration through a vapour resistant barrier
- Reliable solution for leading cables, hoses and other media carriers out on the roof
- Professional penetration through waterproof that does not require either ordinary inspections or maintenance

Ventilation of flat roofs and piping ventilation

Type	DN	Section [cm²]	Dimensions [mm]				
			a*	b*	c	d	e*
TWO a TWOP 50	50	15	360	332	110	250	200
TWO a TWOP 75	70	37	360	332	110	250	200
TWO a TWOP 110	100	85	360	332	160	250	200
TWO a TWOP 125	125	111	360	332	160	250	200

TWO

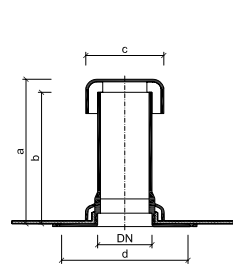

TWOP

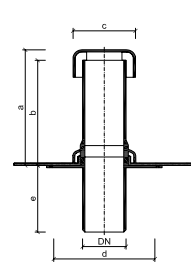

Penetration for cables and base plate

Type	DN	Section [cm²]	Dimensions [mm]					
			a*	b*	c	d	e*	f*
TWP a TWOD 50	50	15	450	332	260	250	200	90
TWP a TWOD 75	70	37	480	332	310	250	200	90
TWP a TWOD 110	100	85	520	332	400	250	200	100
TWP a TWOD 125	125	111	545	332	440	250	200	100

TWP

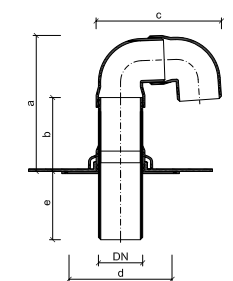

TWOD

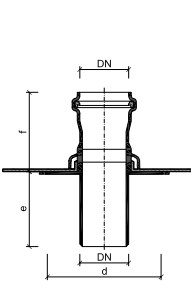

* optionally extension up to 2000 mm to order
** length of TWOD product

Vents, sewerage ventilation, penetrations for cables with integrated bitumen sleeve

BIT	Version	Type	Dimensions
	TOPWET roof vent with an integrated sleeve of a modified bitumen strip, including a rain cap. Height 300 mm, option of extension up to 2000 mm on request.	TWO 50 BIT TWO 75 BIT TWO 110 BIT TWO 125 BIT	DN 50 DN 70 DN 100 DN 125
	TOPWET sewerage ventilation for connection to vent piping with an integrated sleeve of a modified bitumen strip, including a rain cap. Height above insulation 300 mm, depth under insulation 180 mm, option of extension up to 2000 mm on request.	TWOP 50 BIT TWOP 75 BIT TWOP 110 BIT TWOP 125 BIT	DN 50 DN 70 DN 100 DN 125
	Penetration through the vapor barrier TOPWET to connect TWOP and TWP to the vapor barrier with an integrated sleeve of a modified bitumen strip. Depth under insulation 180 mm, option of extension up to 2000 mm on request. This product can not be used as a penetration element for the lower structure.	TWOD 50 BIT TWOD 75 BIT TWOD 110 BIT TWOD 125 BIT	DN 50 DN 70 DN 100 DN 125
	TOPWET penetration for cables with an integrated sleeve of a modified bitumen strip. Height above insulation 300 mm, depth under insulation 180 mm, option of extension up to 2000 mm on request.	TWP 50 BIT TWP 75 BIT TWP 110 BIT TWP 125 BIT	DN 50 DN 70 DN 100 DN 125

Option to supply with custom made sleeve (EPDM, TPO, FPO, PR, STE - suitable for cold liquid applied applications. For more information please see page 9. Extended version subject to price increase. Please contact us for further details.

Vents, sewerage ventilation, penetrations for cables with integrated PVC sleeve

PVC	Version	Type	Dimensions
	TOPWET roof vent with an integrated sleeve of PVC membrane, including a rain cap. Height 300 mm, option of extension up to 2000 mm on request.	TWO 50 PVC TWO 75 PVC TWO 110 PVC TWO 125 PVC	DN 50 DN 70 DN 100 DN 125
	TOPWET sewerage ventilation for connection to vent piping with an integrated sleeve of PVC membrane, including a rain cap. Height above insulation 300 mm, depth under insulation 180 mm, option of extension up to 2000 mm on request.	TWOP 50 PVC TWOP 75 PVC TWOP 110 PVC TWOP 125 PVC	DN 50 DN 70 DN 100 DN 125
	Penetration through the vapor barrier TOPWET to connect TWOP and TWP to the vapor barrier with an integrated sleeve of PVC membrane. Depth under insulation 180 mm, option of extension up to 2000 mm on request. This product can not be used as a penetration element for the lower structure.	TWOD 50 PVC TWOD 75 PVC TWOD 110 PVC TWOD 125 PVC	DN 50 DN 70 DN 100 DN 125
	TOPWET penetration for cables with an integrated sleeve of PVC membrane. Height above insulation 300 mm, depth under insulation 180 mm, option of extension up to 2000 mm on request.	TWP 50 PVC TWP 75 PVC TWP 110 PVC TWP 125 PVC	DN 50 DN 70 DN 100 DN 125

Option to supply with custom made sleeve (EPDM, TPO, FPO, PR, STE - suitable for cold liquid applied applications. For more information please see page 9. Extended version subject to price increase. Please contact us for further details.

Vents and penetrations

Ventilation of roofs, sewerage and cable penetrations



- A simple construction for effective ventilation of two-membrane roofs
- Anchoring points for fixed anchoring in the load-bearing structure of the roof membrane
- Integrated waterproof sleeve for reliable connection to the roofing
- Brand new products for professional finish of the ventilation pipes of the sewerage
- Usable for all the common ventilation pipes DN 150
- A reliable solution for leading the cables and other media carriers to the roof
- Professional penetration through waterproof not requiring any checks or maintenance

Ventilation of flat roofs and sewerages

Type	DN	Cross section [cm²]	Dimensions [mm]				
			a*	b*	c	d	e*
TWO a TWOP 160	150	186	510	270	260	345	300

TWO

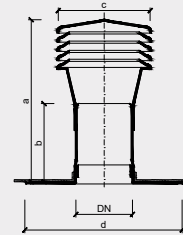

TWOP

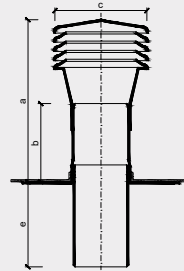

Cable penetrations and the baseplate

Type	DN	Cross section [cm²]	Dimensions [mm]					
			a*	b*	c	d	e*	f*
TWP a TWOD 160	150	186	610	420	260	345	300 (200**)	125

TWP

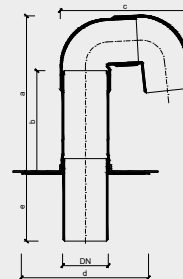

TWOD

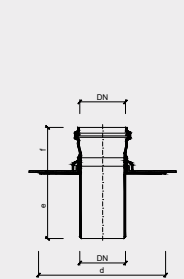

* extension up to 2000mm on request
 ** length by the TWOD product

Vents, sewerage ventilation, penetrations for cables with an integrated bitumen sleeve

BIT	Version	Type	Dimensions
	TOPWET roof vent with an integrated sleeve of a modified bitumen strip, including a rain cap. Height 300 mm, option of extension up to 2,000 mm on request.	TWO 160 BIT	DN 150
	TOPWET sewerage ventilation for connection to the ventilation pipe with an integrated sleeve from a modified bitumen strip, including a rain cover. The height above the insulation is 300 mm, the depth below the insulation is 300 mm, on request it is possible to extend up to 2,000 mm.	TWOP 160 BIT	DN 150
	Penetration through the vapor barrier TOPWET to connect TWOP and TWP to the vapor barrier with an integrated sleeve of a modified bitumen strip. Depth under insulation 200 mm, option of extension up to 2,000 mm on request. This product can not be used as a penetration element for the lower structure	TWOD 160 BIT	DN 150
	TOPWET penetration for cables with an integrated sleeve from a modified bitumen strip, including a rain cover. The height above the insulation is 300 mm, the depth below the insulation is 180 mm, on request it is possible to extend up to 2,000 mm.	TWP 160 BIT	DN 150

Option to supply with custom made sleeve (EPDM, TPO, FPO, PR, STE - suitable for cold liquid applied applications. For more information please see page 9. Extended version subject to price increase. Please contact us for further details.

Vents, sewerage ventilation, penetrations for cables with an integrated PVC sleeve

PVC	Version	Type	Dimensions
	TOPWET roof vent with an integrated sleeve of PVC membrane, including a rain cap. Height 300 mm, option of extension up to 2,000 mm on request.	TWO 160 PVC	DN 150
	TOPWET sewerage ventilation for connection to the ventilation pipe with an integrated sleeve from the waterproof membrane on PVC basis, including a rain cover. The height above the insulation is 300 mm, the depth below the insulation is 300 mm, on request it is possible to extend up to 2,000 mm.	TWOP 160 PVC	DN 150
	Penetration through the vapor barrier TOPWET to connect TWOP and TWP to the vapor barrier with an integrated sleeve of PVC membrane. Depth under insulation 200 mm, option of extension up to 2,000 mm on request. This product can not be used as a penetration element for the lower structure.	TWOD 160 PVC	DN 150
	TOPWET penetration for cables with an integrated sleeve from the waterproof membrane on PVC basis, including a rain cover. The height above the insulation is 300 mm, the depth below the insulation is 180 mm, on request it is possible to extend up to 2,000 mm.	TWP 160 PVC	DN 150

Option to supply with custom made sleeve (EPDM, TPO, FPO, PR, STE - suitable for cold liquid applied applications. For more information please see page 9. Extended version subject to price increase. Please contact us for further details.

Ventilation turbines

Turbines for ventilation of the vented roofs and building interior



- They smoothly and constantly ventilate the vented roofs area and building interiors
- Made from highly resistant materials
- Ventilation with zero electricity consumption
- Stabilisation of temperatures and constant condensing humidity drying and draining from the roof
- Natural ventilation even in places where a different way of ventilation is difficult or impracticable
- It prevents condensate formation and thus also formation of rot and mildew
- To order it is also possible to make another colour version

Ventilation turbines

Type	Dimensions [mm]					Ventilation of m ³ /h with the wind of 4 m/s
	a	b	c	d	e	
TW TUR 12	300	430	300	635	460	750
TW TUR 14	350	500	300	635	490	850
TW TUR 16	400	550	300	785	630	1600
TW TUR 20	500	650	300	905	740	2100

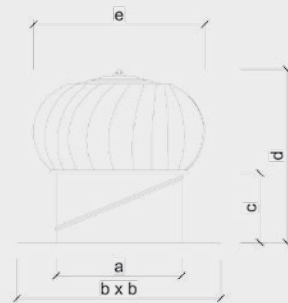

Ventilation turbines

Accessories	Version	Type	Diameter
<p>A ventilation turbine including its base for constant ventilation of the vented roofs, under roof areas, shafts in blocks of flats etc. it is a maintenance free product made of quality materials with a long-term life and no-cost operation. The turbine is made of aluminium and its base is from a galvanized sheet.</p>		TW TUR 12	12"/300 mm
		TW TUR 14	14"/350 mm
		TW TUR 16	16"/400 mm
		TW TUR 20	20"/400 mm

Residential turbines

Accessories	Version
	<p>The vertical design of the turbine blades provides high efficiency and suction output when discharging the heat load from the attic area and in combination with ventilation dampers also high-quality ventilation and cooling of the residential area. The turbine suction neck diameter is 250 mm. The turbine construction, its shape and location of the double bearing system enables high resistance in case of adverse weather conditions and strong wind – it was tested for resistance to wind of 216 km/hour.</p>
	<p>Thanks to the adjustable joint from 0 to 45 degrees, the turbine can be installed easily on all types of roofing. The turbine, adjustable joint and base is offered in 6 colour shades. Designed specially for ventilation of houses, flats and lofts.</p>
	<p>A completely new vertical design of turbine blades provides high efficiency and suction output for ventilation of small rooms. The turbine suction neck diameter is 150 mm. The turbine construction, its shape and location of the double bearing system enables high resistance in case of adverse weather conditions and strong wind – it was tested for resistance to wind of 216 km/hour. Thanks to the universal spacing of the base and the adjustable joint from 0 to 45 degrees, the Turboventura turbine can be installed easily on all types of roofing. The basic version of the turbine neck and base is in black colour. Ventilation of flat and inclined roofs, cellars, boiler rooms and workshops.</p>

Industrial turbines

Accessories	Version
	<p>Turbines for ventilation of large constructions – their suction force is three times bigger compared to onion-shaped turbines of the same diameter. The suction output is influenced by stack effect (60 %). The aerodynamic shape of the turbine and the vertical arrangement of the blades ensures deep suction along the whole height of the building, unlike so-called onion-shape turbines with the effective suction up to 3.5 m of the construction height. Use: shaft ventilation in blocks of flats, hotels, production and warehousing halls, supermarkets and industrial constructions.</p>

For a custom-made design of the best ventilation system, please contact our technical support line | support@topwet.cz



Edge dividers

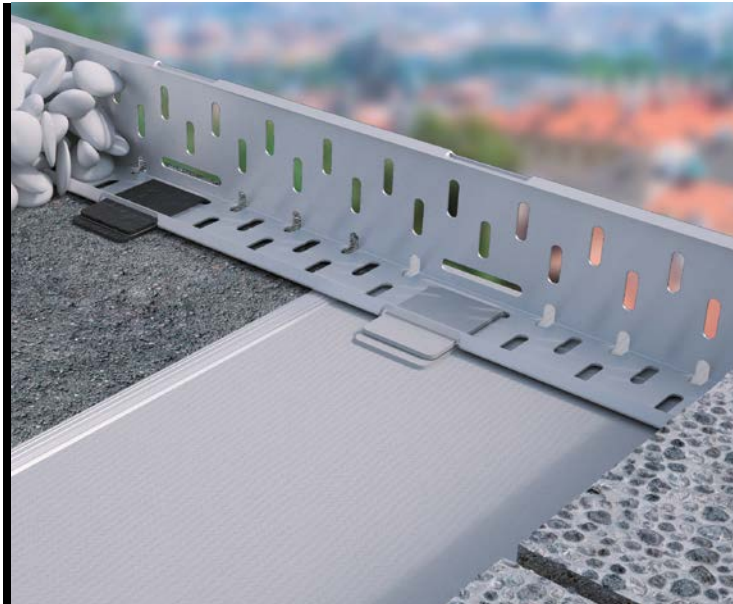

Other roof elements



Edge dividers

- For roofs with load increasing layer of gravel and pavement profile completion
- Aluminum moulding for all types of waterproof systems
- A wide selection of dimensions
- Custom production
- Easy installation
- Connecting piece as a part of each moulding
- The length of 2 m

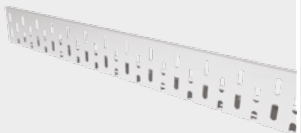
Edge dividers

Accessories	Version	Type	Dimensions of moulding: height / base / length
 <p>Edge dividers for roofs with a load increasing layer of gravel and the completion of the pavement profile. Material: Aluminum with the thickness of 1,5 mm, the length of the moulding of 2000 mm. The moulding has holes – every 250 mm - for the passage of the blank of all kinds of waterproof systems. The stiffness of the moulding is secured by 10 mm bending at the ends of both arms. Supplied with connecting piece for easy connection to another moulding; the delivery time of the custom moulding depends on the ordered quantity. Mounting the moulding to the base is done using a waterproof tape.</p>		TW KL AL 40 TW KL AL 50 TW KL AL 60 TW KL AL 70 TW KL AL 80 TW KL AL 90 TW KL AL 100 TW KL AL __	40 mm / 65mm / 2000 mm 50 mm / 65mm / 2000 mm 60 mm / 65mm / 2000 mm 70 mm / 65mm / 2000 mm 80 mm / 80mm / 2000 mm 90 mm / 80mm / 2000 mm 100 mm / 80mm / 2000 mm __ mm / 80mm / 2000 mm
		TW KL 40 TW KL 50 TW KL 65 TW KL 90	40 mm / 65mm / 2000 mm 50 mm / 65mm / 2000 mm 65 mm / 65mm / 2000 mm 90 mm / 65mm / 2000 mm
 <p>Edge dividers for roofs with a load increasing layer of gravel and the completion of the pavement profile for roofs and terraces with the main PVC waterproof layer. Material: plastic-coated metal sheet with the total thickness of 1.6 mm, length of the moulding of 2000 mm. The stiffness of the moulding is secured by bending of 10 mm at ends of both arms. Supplied with connecting piece for easy connection of another moulding. The delivery time of the custom made moulding is depending on the ordered quantity. At the moulding there are high frequency welded 3-5 pieces of blanket of foil mPVC 80x130 mm for easy mounting. A different color execution is available for a surcharge of +20 %.</p>			

Other roof elements

Catchers, supports, penetrations and other accessories

Snow catcher for roofs with the main PVC waterproof sleeve

Accessories	Version	Type	Minimum purchase
		TW SZ	5 pcs
		TW SZM	5 pcs
		TW SZ RAL	50 pcs

Snow catcher for roofs with the main PVC waterproof layer - other

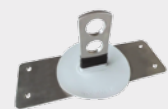
Accessories	Version	Type	Minimum purchase
		TW SZ 2TR	3 pcs

Lightning conductor holder

Accessories	Version	Type	Height
		TW HR 10 TW HR 12	120 mm 120 mm
		TW HR 10 MANZETA TW HR 12 MANZETA	120 mm 120 mm

Foil cleaner on mPVC basis

Accessories	Version	Type	Volume
		TW CLEANER 5	5 l
		TW CLEANER 1	1 l
		TW CLEANER 0,25	0,25 l

Siphonic drainage systems



Siphonic systems

High performance drainage

- Reduced roof water levels required to trigger the siphonic action
- Low noise levels and maximum operation stability
- No swirls and vibration elimination thanks to special design
- Wide range of drainage flows (up to 65 l/s with 110 mm diameter)
- The system is suitable on roofs covered with any type of waterproofing material
- Easy installation inside the gutters, even of small dimensions
- Extremely reliable connection with the Valsir HDPE system
- The main components of the outlets are made of stainless steel or molded aluminium alloy
- European Standard EN 1253 certification
- The completely recyclable product



The advantages of siphonic systems

Financial & Material savings

When compared to conventional systems, siphonic system requires a lower number of roof outlets and allows a substantial reduction in pipe diameters, in the number of fittings required and in the number of downpipes: this results in savings of up to 80% on vertical pipes and from 20% to 30% across the entire system.

Space saving and Increased design flexibility

The roof outlets are connected to single horizontal collector pipes that are fitted without fall and the downpipes are positioned anywhere along the building perimeter, thus avoiding any interference. Complete control over downpipe location and absence of embedded pipes causes increased design flexibility of the siphonic system.

High performance

When in operation drainage pipes flow at 100% over the entire system. Draining speed is therefore greater resulting in the self-cleaning action of the pipework.

TOPWET Roof siphonic outlet

Version	Type	Dimensions
 <p>The roof outlet intended for syphonic drainage systems with an integrated sleeve from a modified bitumen sheet. A vertical variant (S) or a horizontal variant (V). As a standard the roof outlet is equipped with a protective basket.</p>	TWR 56 BIT S	DN 56
	TWR 110 BIT S	DN 110
	TWR 56 BIT V	DN 56
	TWR 110 BIT V	DN 110
<p>The roof outlet is intended for syphonic drainage systems with an integrated sleeve from PVC based hydro-insulation foil. A vertical variant (S) or a horizontal variant (V). As a standard, the roof outlet is equipped with a protective basket.</p>	TWR 56 PVC S	DN 56
	TWR 110 PVC S	DN 110
	TWR 56 PVC V	DN 56
	TWR 110 PVC V	DN 110

Siphonic systems

Principle of negative pressure drainage



How does it work?

A siphonic rainwater drainage system is based on the same principle as a siphon. The siphon is in general a reversed U shaped pipe used to pour a fluid from one container to another located in a lower position.

This process only starts when the pipe is completely full and continues until a balance between the two containers is reached: either when the two containers reach the same level or when the fluid level in the higher container goes below the pipe inlet section. The bigger the difference, the stronger the driving force and, as a consequence, the greater the flow speed in the pipe.

The performances of the siphonic drainage system are therefore decidedly better than those of a conventional system. When the siphonic drainage system works at full capacity, the "siphon effect" is triggered. As a consequence, the speed and the flow rates of the system are rapidly increased.

Siphonic systems

Installation and fastening

- Easy installation
- Wide range of fittings such as access pipes, elbows, reducers and reduced branches
- Possible installation on walls or ceiling
- Capacity of absorbing heat expansion and contraction of the drainage network
- The clips are anchored to the pipes and support rail using high resistance bolts
- Alignment of clips and Valsir HDPE pipes with the support rail

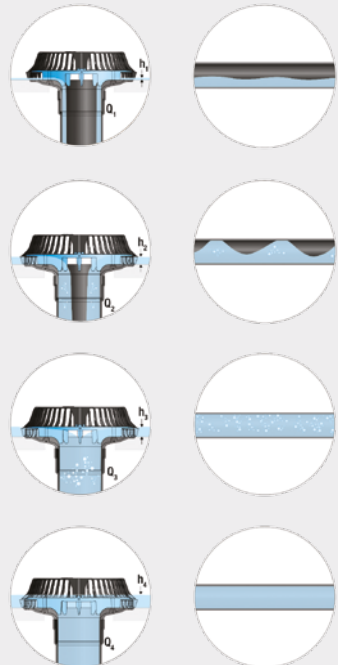

Flow stages

Stage 1

With a moderate flow, of 10 or 15% of the design rainfall intensity value, the roof outlet works as in a conventional system and the flow is defined "gravity flow", since air content in the pipes is elevated.

Stage 2

When the water discharged from the roof is between 10 to 15% and 60% of the full bore flow condition, water flow is discontinuous and the system therefore fluctuates from a gravitational flow regime to a full siphonic action. At these rainfall values the water that accumulates on the roof fills the outlet, cutting off air flow into the pipe and triggering the siphonic action. The speed of water discharged therefore increases, which results in falling water levels, allowing air to be drawn into the piping network and breaking the siphon; for this reason this stage is called "plug flow".

Stage 3

When the water discharged is between 60% and 95% of the design rainfall intensity value, the pipes are completely full of water, although many air bubbles are still present. This stage is called "bubble flow" and features high flow speed generated by the siphonic effect.

Stage 4

When the flow is over 95% of the design rainfall intensity value, the siphonic effect operates at full capacity reaching maximum velocity with no air entering the pipes. This stage is called "full flow" and does not produce noise or vibrations.

Syphonic pipeline joining methods

Manual butt-welding

Thanks to the extremely light weight of polyethylene, pipes and/or fittings up to a 63 mm diameter can be butt-welded using a manual process which involves the use of a heating plate only. It's an extremely convenient joining method on site.

Machine butt-welding

This method is suitable for the special butt-welding machines that weld up to 315 mm diameters. This process is extremely useful for the prefabrication of system parts that are then installed and connected on site using other joining methods, such as welding through electrofusion sleeves.

Electrofusion couplings

By means of the electrofusion couplers that are available in 40 mm diameters to 315 mm diameters, all system parts can be prepared. Two types of welding machines guarantee rapid, easy and extremely reliable welding.

Design & Support

- TOPWET provides projects of the syphonic systems designed with the use of the advanced specialized software
- Individual approach to each project
- Each project includes the cost calculation



Continuous balcony outlets and steel pipes

Drainage of balconies and terraces

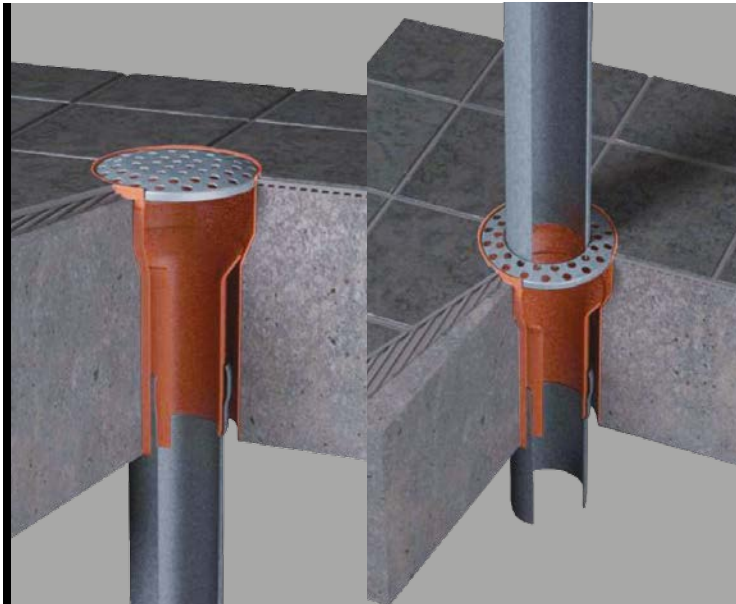

- A continuous drainage system enables draining water from the individual balconies without using a side connection for every floor
- The outlets and pipes are made from hot-dip galvanized steel, which ensures higher mechanical resistance against external influences
- Simple assembly and maintenance
- Connection to KG and HT systems using a simple transitional piece
- Preparation of a technical solution for a specific construction free of charge

LORO waste piping

Version

Accessories



LORO waste piping from hot-dip galvanized steel with an internal layer from two-component epoxide of reddish brown colour with a deep flange for connecting pipes, supplied without an O-ring. The piping DN 50–150 is supplied in the length from 250 to 3000 mm.

It can be supplied including all the accessories, elbows, branching, sleeves, reductions, transmission pieces etc.

Technical advice about the system and assistance at the stage of project documentation is provided within the scope of technical support free of charge.



TOPSAFE

FALL PROTECTION
SAFETY SYSTEMS

Safety systems
TOPSAFE elements against falling
from height and to depth



www.topsafe.cz

What services are provided in TOPSAFE



Proposals, implementation & support

- We provide own delivery and assembly of anchoring points
- Available net of trained certified assembly companies
- We perform inspections and revisions of installed systems
- Elaboration of design proposals free of charge
- Proposal of safety solutions determined to your roof
- Details of anchoring points in DWG for free of charge download
- We offer only stainless steel products certified in accordance with valid standards

Anchoring points for concrete construction

Safety on flat roofs

- A wide range of goods for arresting and retention systems
- All the elements are of stainless steel
- Anchoring material is always part of each anchoring point
- The height of the anchoring points up to 1000 mm
- Possible application also in hollow panels

Possible ways of anchoring

- By means of mechanical spacers
- Using two-component chemical anchor
- Gripping with a counter-board

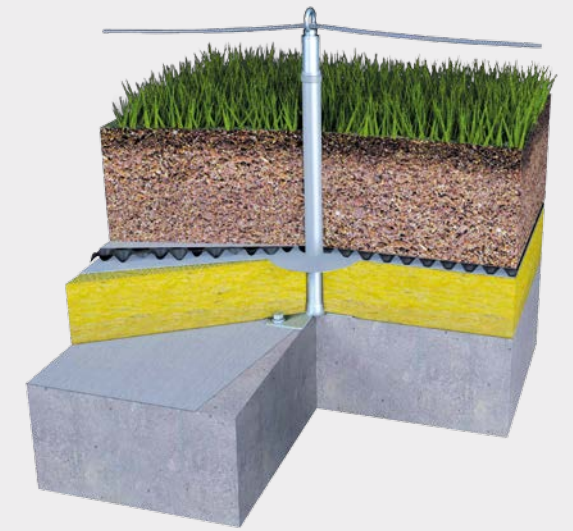

Marking of TOPSAFE products for easy selection



Can be complemented with a reinforcing pipe – then it can be used as end and turn points in the systems with permanent anchoring lines from a stainless steel rope



Suitable for use as end and turn points in the systems with permanent anchoring lines from a stainless steel rope



Suitable for use only as an intermediate point in the straight sections in the systems with permanent anchoring lines from a stainless steel rope



Made of stainless steel



Suitable for use as corner and turn points in the systems with permanent anchoring lines from a stainless steel rope



Maximum number of users attached to the anchoring device

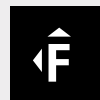

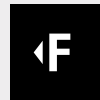

Can be loaded in both vertical and horizontal direction





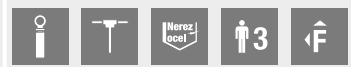





Can be loaded in horizontal / vertical direction



Anchoring points for concrete construction

Product description	Construction description	Lengths [mm]	Type marking
 <p>A stainless steel anchoring point for concrete constructions. The column diameter is 16 mm. Installation in a pre-drilled opening using chemical anchor (not included in the delivery). Intended for concrete of category C20/25 and higher. In order to be used as an end and turn point in the systems with a stainless steel rope. When longer than 100 mm, it must be complemented with a reinforcing pipe.</p> 	Concrete slab/girder of minimum thickness of 140 mm	0-1000	TSL-0-B3 TSL-100-B3 TSL-200-B3 TSL-300-B3 TSL-400-B3 TSL-500-B3 TSL-600-B3 TSL-xxx-B3
 <p>A stainless steel anchoring point for flat roofs with load-bearing construction from a concrete slab. The column diameter is 16 mm. Easy and fast installation in a pre-drilled opening in the concrete using mechanical spacing anchor in the bottom part of the column. Intended for concrete of category C20/25 and higher.</p> 	Concrete slab/girder of minimum thickness of 125 mm	0-1000	TSL-300-BE3 TSL-400-BE3 TSL-500-BE3 TSL-600-BE3 TSL-xxx-BE3

Anchoring points for concrete construction

Product description	Construction description	Lengths [mm]	Type marking
 <p>A stainless steel anchoring point for flat roofs with load-bearing construction from a concrete slab. The anchoring point has a base of 150x150 mm and the fortified column diameter is 42 mm. Installation in pre-drilled openings is performed using mechanical spacing anchors or chemical anchor (not included in the delivery). Intended for concrete of category C20/25 and higher.</p> 	Concrete slab/girder of the minimum thickness of 80 mm	200-1000	TSL-200-BSR10 TSL-300-BSR10 TSL-400-BSR10 TSL-500-BSR10 TSL-600-BSR10 TSL-xxx-BSR10
 <p>A stainless steel anchoring point for various types of bases. The anchoring point has a base of 200x200 mm and a counter-board of 100x100 mm. The fortified column diameter is 42 mm. Installation is performed by gripping of one or more sufficiently bearing layers. When ordering, it is necessary to specify the expected gripping thickness.</p> 	Hollow panels with the minimum thickness of the hollow covering layer of 25 mm	300-800	TSL-300-HD10 TSL-400-HD10 TSL-500-HD10 TSL-600-HD10 TSL-xxx-HD10
 <p>A stainless steel anchoring point for various types of bases. The anchoring point has a base of 200x200 mm and a counter-board of 100x100 mm. The fortified column diameter is 42 mm. Installation is performed by gripping of one or more sufficiently bearing layers. When ordering, it is necessary to specify the expected gripping thickness.</p> 		150-600	TSL-150-K10 TSL-300-K10 TSL-400-K10 TSL-500-K10 TSL-600-K10
 <p>A stainless steel anchoring point for installation on concrete girders. The anchoring point has a base and a counter-board with the dimensions 200x200 mm. The column diameter is 16 mm. Installation is performed by gripping of the girder with the counter-board using four threaded rods (included in the delivery). The maximum girder width is 150 mm. When ordering, it is necessary to specify the expected gripping thickness.</p> 		150-500	TSL-150-STK10 TSL-300-STK10 TSL-400-STK10 TSL-500-STK10

Anchoring points for concrete construction

Product description	Construction description	Lengths [mm]	Type marking
 <p>A stainless steel anchoring point for concrete beams. The anchoring point comprises of an angle iron and a pillar with the diameter of 16 mm. It is installed by means of threaded rods and a two-component chemical anchor. It is intended for concrete of C20/25 grade.</p> 		200-600	TSL-200-BSL3 TSL-300-BSL3 TSL-400-BSL3 TSL-500-BSL3 TSL-600-BSL3
 <p>A rotary stainless steel anchoring point for concrete constructions with the thread M16 suitable for application in all positions (above the head, upside down, ceiling). Installation in a pre-drilled opening in the concrete by means of chemical anchor (not included in the delivery). Standard colour is yellow (RAL 1003). Intended for concrete of category C20/25 and higher.</p> 			TSL-RB3
 <p>A stainless steel anchoring point for concrete constructions with the thread M12. Installation in a pre-drilled opening in the concrete by means of chemical anchor (not included in the delivery). Intended for concrete of category C20/25 and higher.</p> 	Concrete slab with the minimum thickness of 130 mm		TSL-B4
 <p>A stainless steel anchoring point for concrete constructions. Installation in a pre-drilled opening in the concrete by means of special mechanical anchor. Intended for concrete of category C20/25 and higher.</p> 	Concrete slab with the minimum thickness of 115 mm		TSL-B5

Anchoring points for trapezoid and sandwich constructions

Safety on flat roofs

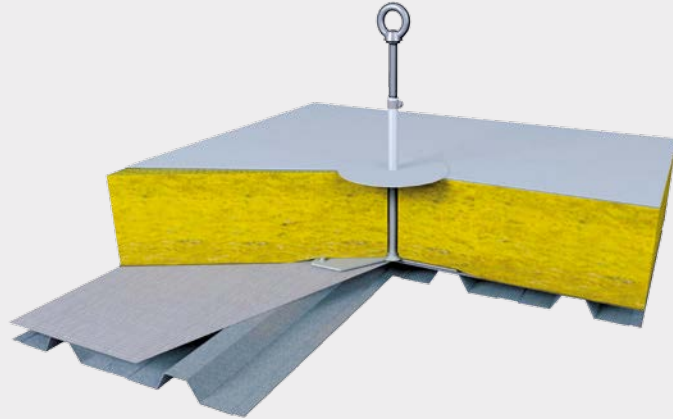





- A wide range of products enabling implementation of the individual points as well as systems with flexible anchoring lines
- Our offer enables anchoring to the trapezoid sheet metal with various wave modulations
- Possible anchoring to trapezoid sheet metal starting from the thickness of 0.63 mm, in case of a riveted connection starting from 0.45 mm
- All the anchoring points are made of stainless steel
- Anchoring material is always part of each rope brackets

Possible ways of anchoring

- By means of hinged anchors
- Riveted connection

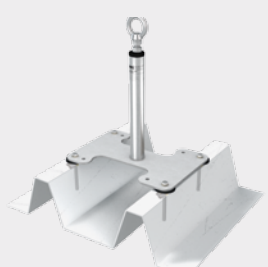
Anchoring points for trapezoid and sandwich constructions

Product description	Construction description	Lengths [mm]	Type marking
 <p>A stainless steel anchoring point for trapezoid sheet metal fitted in both positive and negative direction. The base dimensions 290x200 mm, the column diameter 16 mm. The installation is made by means of four special hinged anchors from the roof surface. Intended for trapezoid sheet metal starting from the thickness of 0.63 mm.</p> 	Trapezoid sheet metal with the minimum thickness of 0.63 mm	150-600	TSL-150-T10 TSL-300-T10 TSL-400-T10 TSL-500-T10 TSL-600-T10
 <p>A reinforced stainless steel anchoring point for trapezoid sheet metal fitted in both positive and negative direction. The base dimensions 290x200 mm, the column diameter 42 mm. The installation is made by means of four special hinged anchors from the roof surface. Intended for trapezoid sheet metal starting from the thickness of 0.63 mm. Optional anchor pitch 160 - 250 mm.</p> 	Trapezoid sheet metal with the minimum thickness of 0.63 mm	150-600	TSL-150-TX10 TSL-300-TX10 TSL-400-TX10 TSL-500-TX10 TSL-600-TX10

Anchoring points for trapezoid and sandwich constructions

Product description	Construction description	Lengths [mm]	Type marking
 <p>A stainless steel anchoring point for a sandwich panel and trapezoid metal sheets. The base dimensions 372x200 mm, the column diameter 16 mm. The installation is made by means of four special hinged anchors from the roof surface. Intended for sheet metal starting from the thickness of 0.5 mm. Optional anchor spacing 288 - 333 mm.</p> 	Sandwich panels Trapezoid sheets	150 300	TSL-150-SW10 TSL-300-SW10
 <p>A stainless steel anchoring point for aluminium sheet metal. The base dimensions 370x370 mm, the column diameter 16 mm. The installation is made by means of six special hinged anchors from the roof surface. Intended for aluminium sheet metal starting from the thickness of 0.7 mm.</p> 	Aluminium trapezoid sheet metals with the minimum thickness of 0.7 mm	300	TSL-300-T10-AL
 <p>A stainless steel anchoring point for trapezoid sheet metal and sandwich panels. It is available in two versions of the base dimensions. The installation is made by means of special stainless steel rivets. Intended for aluminium sheet metal starting from the thickness of 0.45 mm.</p> 	Sheet metal with the minimum thickness of 0.45 mm		TSL-R-250 TSL-R-333
 <p>A stainless steel anchoring point for a trapezoid sheet metal fitted in both positive and negative directions. It is intended for one person or connection in a safety net. The installation is made by means of a special hinged anchor from the roof surface. Intended for trapezoid sheet metal starting from the thickness of 0.88 mm (for the safety net 0.75 mm) and 1.5 mm for aluminium sheet metal.</p> 	Trapezoid sheet metal with the minimum thickness of 0.75 mm		TSL-T6

Anchoring points for wooden constructions

Safety on flat roofs

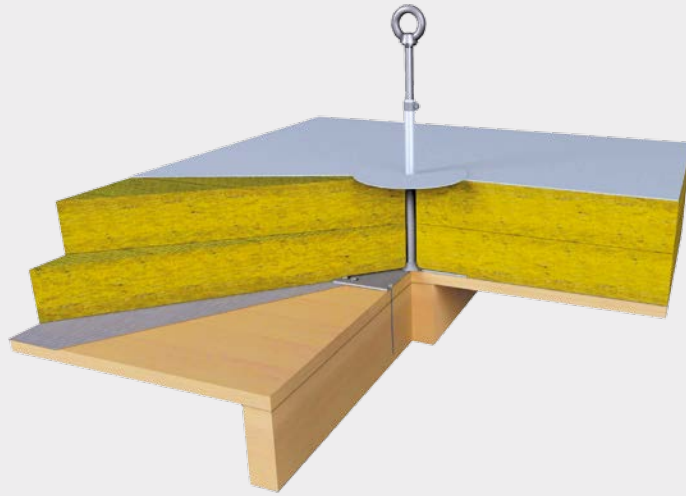



- An extensive offer enables anchoring in various base constructions
- All the elements are from stainless steel
- A wide range of products enabling implementation of individual points as well as systems with a flexible anchoring line
- Anchoring material is always part of the package





Possible ways of anchoring

- By means of a special self-drilling screw
- By self-drilling stainless steel screws in the boarding and the girder
- By self-drilling screws only in the boarding
- By side screwed connection

Anchoring points for wooden constructions

Product description	Construction description	Lengths [mm]	Type marking
 <p>A stainless steel anchoring point for thin wooden constructions. The anchoring point has a base of 200 x 200 mm and a pillar with the diameter of 16 mm. It is installed by means of 16 stainless steel self-drilling screws fastened in the wooden boarding or OSB board. It is intended for boarding with the min. thickness of 24 mm and OSB boards with the minimum thickness of 18 mm. When used as the end point and break point in the systems with a stainless steel wire rope, if longer than 100 mm, it must be complemented with a reinforcing pipe.</p>	Boarding from wooden plank with the min. thickness of 24 mm, OSB boarding with the min. thickness of 18 mm	150-500	TSL-150-H1016 TSL-300-H1016 TSL-400-H1016 TSL-500-H1016
 <p>A stainless steel anchoring point for thin wooden constructions. The anchoring point comprises of a round base (the diameter of 400 mm) and a pillar with the diameter of 16 mm. It is installed by means of 24 stainless steel self-drilling screws fastened in the wooden boarding or OSB board. It is intended for boarding with the min. thickness of 18 mm and OSB boards with the min. thickness of 12 mm. When used as the end point and break point in the systems with a stainless steel wire rope, it must be complemented with a reinforcing pipe.</p>	Boarding from wooden planks with the min. thickness of 18 mm, OSB boarding with the min. thickness of 12 mm	150 - 600	TSL-150-H1024 TSL-300-H1024 TSL-400-H1024 TSL-500-H1024 TSL-600-H1024

Anchoring points for wooden constructions

Product description	Construction description	Lengths [mm]	Type marking
 <p>A stainless steel anchoring point for wooden constructions. The column diameter is 16 mm. Easy and fast installation in the pre-drilled opening in the wood and gripping by means of a special base and a back-nut. Intended for girders of minimum 100x120 mm.</p>	Girder with the minimum dimensions of 100 x 120 mm	100-500	TSL-100-HW3 TSL-200-HW3 TSL-300-HW3 TSL-400-HW3 TSL-500-HW3
 <p>A stainless steel anchoring point for wooden constructions comprising of a load-bearing beam and wooden boarding. The anchoring point has the base of 200x200 mm and the column diameter is 16 mm. Installation is performed by means of 14 shorter stainless steel self-drilling screws connected in the wooden boarding and two long ones connected in the wooden beam. Intended for wooden girders of minimum 60x120 mm.</p>	A wooden girder with the minimum dimensions of 60x120 mm	150-600	TSL-150-H10(14+2) TSL-300-H10(14+2) TSL-400-H10(14+2) TSL-500-H10(14+2) TSL-600-H10(14+2)
 <p>A stainless steel anchoring point for wooden girders. The anchoring point comprises of an angle piece and a column with the diameter of 16 mm. Installation is performed by means of two stainless steel threaded bars placed in pre-drilled openings and secured with back-nuts. Intended for girders of minimum 100x120 mm.</p>	A wooden girder with the minimum dimensions of 100x120 mm	200-600	TSL-200-SL3 TSL-300-SL3 TSL-400-SL3 TSL-500-SL3 TSL-600-SL3
 <p>A reinforced stainless steel anchoring point for wooden girders. The anchoring point comprises of an angle piece and a column with the diameter of 42 mm. Installation is performed by means of two stainless steel threaded bars placed in pre-drilled openings and secured with back-nuts. Intended for girders of minimum 100x120 mm.</p>	A wooden girder with the minimum dimensions of 100x120 mm	100-500	TSL-100-SLR3 TSL-200-SLR3 TSL-300-SLR3 TSL-400-SLR3 TSL-500-SLR3

Anchoring points for steel constructions

Safety on flat roofs







- All the elements are made of stainless steel
- Anchoring material is always part of the package
- The height of the anchoring points up to 1000 mm
- Solution also for enclosed profiles
- Rotary anchoring points









Possible ways of anchoring

- By means of a screwed connection
- By gripping with a counter-board
- Screwed connection in a pre-drilled thread









Anchoring points for steel constructions

Product description	Construction description	Lengths [mm]	Type marking
 <p>A stainless steel anchoring point for steel constructions. The column diameter is 16 mm. Installation in a pre-drilled opening in the girder by means of a back-nut. In order to be used as an end and turn point in the systems with a stainless steel rope, when longer than 100 mm, it must be complemented with a reinforcing pipe.</p> 	Steel girder	0-1000	TSL-0-ST3 TSL-100-ST3 TSL-300-ST3 TSL-400-ST3 TSL-500-ST3 TSL-600-ST3 TSL-xxx-ST3
 <p>A stainless steel anchoring point for steel girders. The anchoring points has a base of 150x150 mm and the reinforced column diameter is 42 mm. Installation is performed by means of four screwed connections in pre-drilled openings.</p> 		200-1000	TSL-200-STSR10 TSL-300-STSR10 TSL-400-STSR10 TSL-500-STSR10 TSL-600-STSR10 TSL-xxx-STSR10

Anchoring points for steel constructions

Product description	Construction description	Lengths [mm]	Type marking
 <p>A stainless steel anchoring point for steel constructions. An anchoring point comprises of an angle iron and a pillar with the diameter of 16 mm. It is installed by means of two stainless steel threaded rods inserted in pre-drilled openings and secured with nuts.</p> 		200 - 600	TSL-200-SRL3 TSL-300-SRL3 TSL-400-SRL3 TSL-500-SRL3 TSL-600-SRL3
 <p>A stainless steel anchoring point for steel girders. The anchoring points has a base of 200x200 mm and the column diameter is 16 mm. Installation is performed by gripping of the load-bearing element with a counter board by means of four threaded bars (included in the delivery). The maximum girder width is 150 mm. When ordering, it is necessary to specify the expected gripping thickness. For use as an end and break point in stainless steel rope systems, it is necessary to add a reinforcing pipe at longer than 100 mm lengths.</p> 	Steel girder with the maximum flange width of 150 mm	150-500	TSL-150-STK10 TSL-300-STK10 TSL-400-STK10 TSL-500-STK10
 <p>A rotary stainless steel anchoring point with the thread M12, M16 or M20 suitable for application mainly in enclosed steel profiles. Installation by screwing into a pre-drilled thread. Standard colour is yellow (RAL 1003).</p> 			TSL-STR3
 <p>A rotary stainless steel anchoring point for steel constructions with the thread M16. Installation by screwing into a pre-drilled thread. Standard colour is yellow (RAL 1003).</p> 			TSL-50-STR3

Anchoring points for steel constructions

	Product description	Construction description	Lengths [mm]	Type marking
	A stainless steel anchoring point for steel constructions with the thread M12. Installation by screwing into a pre-drilled thread.	Steel girder with the minimum flange thickness of 5 mm		TSL-ST4
				
	A stainless steel anchoring point for steel constructions with the thread M10. Installation by screwing into a pre-drilled thread.	Steel girder		TSL-ST5
				
	A rotary stainless steel anchoring point for steel constructions. Installation by screwing into a pre-drilled thread.			TSL-STR5
				
	Stainless steel anchoring point intended specially for anchoring on solar panels constructions. The maximum dimension of the profiles for gripping is 50x50 mm.	Profiles up to the dimension of 50x50 mm		TSL-150-SO10
				

Anchoring points for rope suspension work





Security during facade cleaning and maintenance

- The anchor eye is always included in the delivery of the rope bracket
- Anchoring points of higher toughness and resistance
- Anchoring points intended for anchoring in solid bases
- Anchoring points can also be used for arresting systems
- Anchoring material is always part of the package
- For elements of TSR type, the package always includes a heat-insulation cover





Possibility of facade cleaning and maintenance using the climbing gear

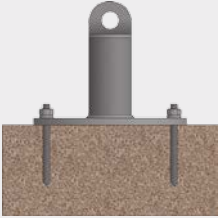

Anchoring points for rope suspension work

	Product description	Construction description	Lengths [mm]	Type marking
	A stainless steel anchoring point for flat roofs with load-bearing construction from a concrete slab. The anchoring point has a base of 150x150 mm and the fortified column diameter is 42 mm. Installation in pre-drilled openings is performed by means of mechanical spacing anchors or chemical anchor (not included in the delivery). Intended for concrete of category C20/25 and higher.	Concrete slab with the minimum thickness of 80 mm	200-400	TSL-200-BSR10 TSL-300-BSR10 TSL-400-BSR10
				
	A stainless steel anchoring point for steel girders. The anchoring point has a base of 150x150 mm and the fortified column diameter is 42 mm. Installation is performed by means of four screwed connections in pre-drilled openings.		200-400	TSL-200-STSR10 TSL-300-STSR10 TSL-400-STSR10
				

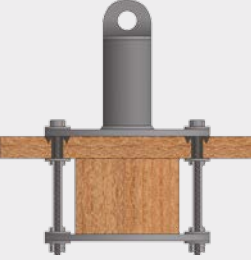
Anchoring points for rope suspension work

	Product description	Construction description	Lengths [mm]	Type marking
	An anchoring point intended for concrete of min. B25 or C20/25. The point is anchored in the base by means of four special screws.	Concrete slab with the minimum thickness of 120 mm	85-1000	TSR-085-B3 TSR-300-B3 TSR-400-B3 TSR-500-B3 TSR-600-B3 TSR-xxx-B3
	An anchoring point intended for steel girders. The point is anchored to the girder using special screws.	Steel girder with the minimum width of 110 mm	300-600	TSR-300-ST TSR-400-ST TSR-500-ST TSR-600-ST
	An anchoring point intended for constructions from wooden load-bearing beams with boarding. The point is anchored by gripping of the beam using a counter-board.	Wooden boarding on the beam with the maximum width of 120 mm	300-500	TSR-300-K8 TSR-400-K8 TSR-500-K8
	An anchoring point intended for side anchoring in the wooden truss. The point is anchored using a screwed connection.	Wooden truss with the minimum height of 250-350 mm	300-500	TSR-300-S9 TSR-400-S9 TSR-500-S9

Rail systems

Façade cleaning solution

- Designed for work in locations known in advance
- Smooth movement along the whole length of rail lines
- Possible turning thanks to a curved rail and a special motorized element
- If placed overhead, elimination of possible falls

It can also be used as a system for work when suspended on rope

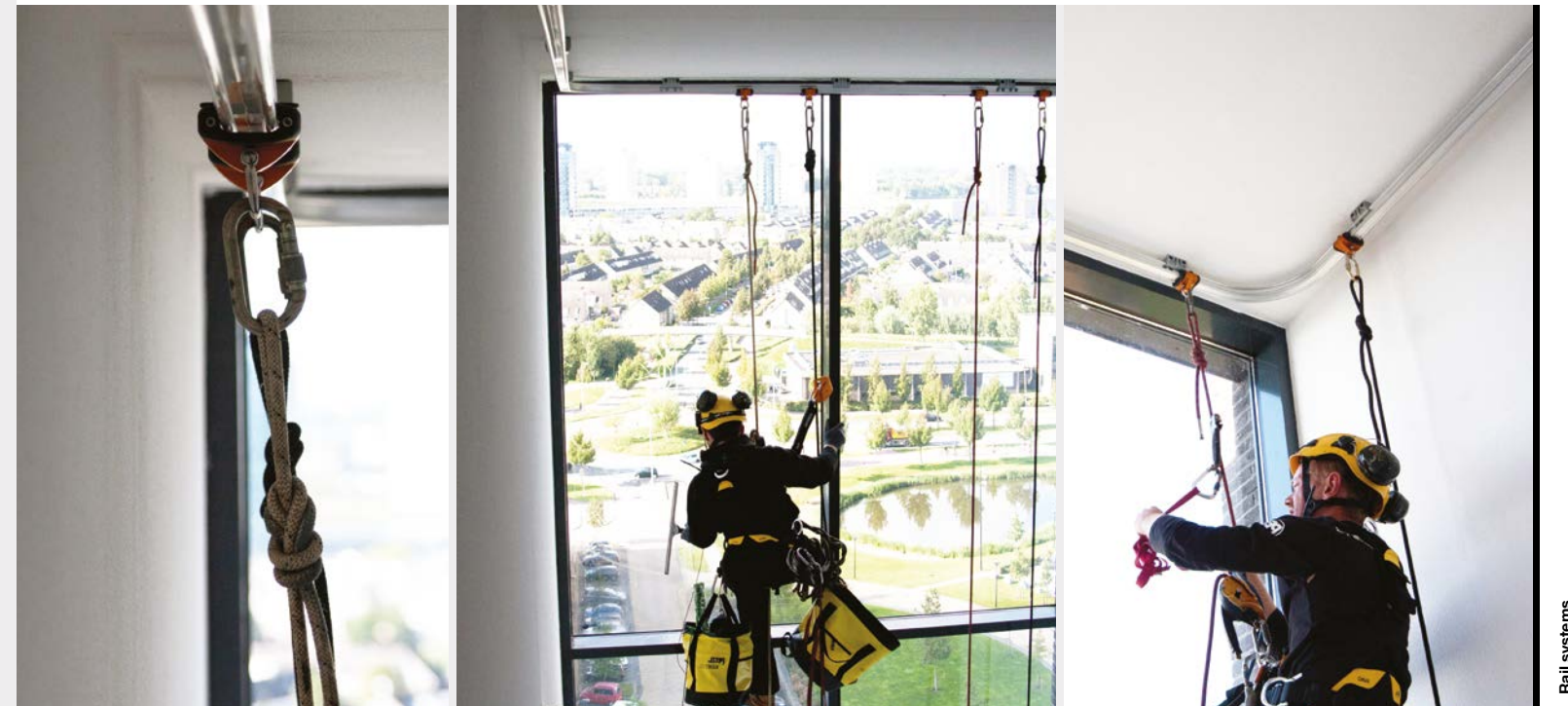



Anchoring points for inclined roofs

Safety on inclined roofs



- All the anchoring points for inclined roofs are certified according to EN 795, roof hooks for laid roofing are also certified according to EN 517
- For all the products we guarantee long life as they are made from quality stainless steel
- When implemented on metal sheet inclined roofs of a higher degree of inclination, it is possible to use a special auxiliary hook for hanging a ladder
- For metal sheet roofs it is possible to supply elements for various types of standing seams

Anchoring points for inclined roofs

Product description	Construction description	Type marking
 <p>A flat roof hook intended for fitting on inclined roofs with laid roofing from patterns. Loaded in all directions. Certified according to EN 795 and EN 517.</p>	Wooden girder with the minimum dimensions of 60 x 120 mm	TSL-DH04P
 <p>A bent roof hook intended for fitting on inclined roofs with laid roof tiles. Loaded in all directions. Certified according to EN 795 and EN 517.</p>	Wooden girder with the minimum dimensions of 60 x 120 mm	TSL-DH04Z

Anchoring points for inclined roofs

Product description	Construction description	Type marking
 <p>An anchoring point for wooden beams. The stainless steel loop with the diameter of 5 mm is very subtle and it does not disturb the appearance of the roof. Easy and fast installation by means of two self-drilling screws directly in the rafter.</p>	Wooden girder with the minimum dimensions of 60 x 120 mm	TSL-LOOP
 <p>An anchoring point for folded roofs. It is suitable for use as an individual point for securing of up to 3 persons.</p>	<p>Minimum thickness of the sheet metal is 0,5 mm</p> <p>Minimum thickness of TiZn and galvanized sheet metal is 0,6 mm</p> <p>Minimum thickness of the copper and aluminium sheet metal is 0,7 mm</p>	TSL-F5 Copper roofs: TSL-F5CU
 <p>An anchoring point for metal sheet roofs. It is suitable for use as an end point in the sections with the stainless steel rope. Types according to the groove distance: 300–450 or 420–660 mm.</p>	<p>Minimum thickness of the sheet metal is 0,5 mm</p> <p>Minimum thickness of TiZn and galvanized sheet metal is 0,6 mm</p> <p>Minimum thickness of the copper and aluminium sheet metal is 0,7 mm</p>	TSL-450-F4 TSL-660-F4 Copper roofs: TSL-450-F4CU TSL-660-F4CU
 <p>An anchoring point for metal sheet roofs. It is suitable for use as an intermediate point in the sections with the stainless steel rope.</p>	<p>Minimum thickness of the sheet metal is 0,5 mm</p> <p>Minimum thickness of TiZn and galvanized sheet metal is 0,6 mm</p> <p>Minimum thickness of the copper and aluminium sheet metal is 0,7 mm</p>	TSL-F4ZW Copper roofs: TSL-F4ZWCU

Collective protection

Mobile railing



- Innovative methods of railing installation
- Made of high quality aluminium
- Resistant to weather conditions
- A wide offer of possible anchoring to the base
- Possibility of anchoring to the base using its own weight
- Low weight ensures easy assembly and low transport costs
- Installation on constructions with the inclination of up to 10°
- The railing height of 1100 mm

Collective protection

Safety bars

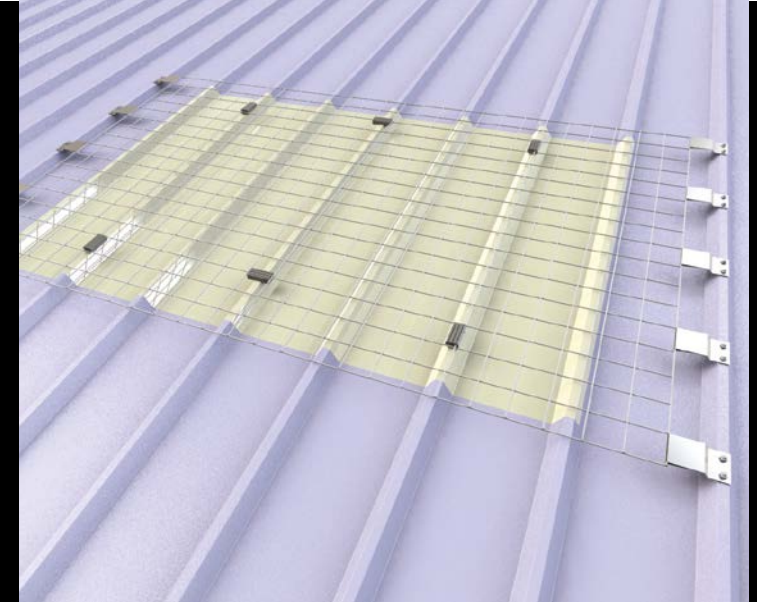

Bars for illumination strips

- Additional assembly on finished illumination strips
- Mechanical anchoring to trapezoid sheet metal or a sandwich panel
- Elimination of the risk of a deep fall at critical places
- Sealed with special gaskets
- Simple installation

Railing

Product description

Type marking



Railing anchored to the base by fusing

A system of roof railing from aluminium and stainless steel. It is anchored to the base from bitumen strips or foil by means of fusing with strips of the corresponding waterproof. The railing height is 1100 mm.

TSG-FU



Mobile railing with a weight

A system of roof railing from aluminium and stainless steel. It does not have to be anchored to the base. The railing is secured by means of the weight. The railing height is 1100 mm.

TSG-VT

© VERTIC

Bars for roof skylights

- Universal modular system for various sizes and configurations of skylights
- Collective protection as the highest level of safety
- Installation in the internal construction does not disturb the appearance
- Simple installation



© VERTIC

Systems for ladders

Vertical protection of persons against fall



- Security with every step when moving on a ladder
- High quality standard
- Simple solution with high efficiency
- For indoor and outdoor usage
- Easy and intuitive use



Industrial systems

Special industrial security







- Security of workers in industrial buildings, such as halls, production plants, warehouses etc.
- Possibility of securing footbridges, crane tracks, servicing places and rack systems
- For industrial systems, it is possible to use basic anchoring points specified in the previous chapters according to the types of the base construction
- Possibility of using individual anchoring points or as a system with a permanent anchoring line
- For special situations, it is suitable to use special anchoring points and constructions specified below











Arresting systems for ladders

Product description	Type marking
 <p>An arresting system for ladders A system for securing of steel and aluminium ladders which are anchored in a fixed way. Securing of up to four persons at a time (it is necessary to use one slider per person). Used with a permanent stainless steel rope 8 mm thick. The upper termination part with an overlap above the ladder of up to 1300 mm. The elements are made from stainless steel.</p> <p>The individual parts of the system: An upper termination part, length 1300 mm An upper termination part, length 300 mm Intermediary handle A lower termination part with a tensioning piece for a stainless steel rope A slider per one person</p>	TSL-HL TSL-HS TSL-HZW TSL-HE TSL-HJ
 <p>CLICK-IT CLICK-IT is a mean of personal security against fall on a permanently installed ladder without having to install another fixed vertical securing system attached to the ladder construction. With its weight of 2 kg it ensures maximum accuracy. Securing is performed by means of two mutually interconnected hooks which are attached to the ladder rungs alternately in such a way that one hook cannot be opened if the other one is not locked automatically. This prevents accidental releasing and security is ensured for the whole ascent or descent on the ladder.</p>	TSL-CLIC

Industrial systems

Product description	Construction description	Type marking
 <p>An anchoring point for installation on a steel girder with the covering strip width from 80 to 320 mm and thickness of 8-16 mm. It is intended for three persons. Easy installation. It is made from hot galvanised steel. It can also be used as a termination point of a permanent rope line.</p> <p></p>		TSL-LT
 <p>Solution for containers A stainless steel anchoring point intended for containers. It is suitable for anchoring to a sandwich panel or trapezoid sheets. An extremely thin profile enables stacking of containers. Anchoring is performed by means of 14 stainless steel rivets. The integrated insulation seals ensure hydro-insulation tightness.</p> <p></p>	Trapezoid sheets of minimum thickness 0,5 mm	TSL-FLAT







Industrial systems

	Product description	Construction description	Type marking
	A mobile anchoring point for installation on a steel girder with the covering strip width from 95 to 300 mm and the maximum thickness of 35 mm. Easy installation and dismantling. Made of aluminium. Weight only 1.5 kg.  	Steel girder	TSL-TQ
	A mobile anchoring point for installation on a steel girder. Choice from five models for covering strips with the width from 120 to 280 mm. Suitable for longer use in the same place, even outside. Made from stainless steel.   	Steel girder	TSL-RB
	Tripod A mobile tripod used for securing of workers in shafts with the entrance hole. It can also be used for rescuing of persons from these areas. Intended for one person. 		TSL-TRIPOLE
	Airanchor A system for securing a person, e.g. on a means of transport (a cistern truck etc.). The base is anchored in the ground in the fixed way. Shoulder reach and secured area according to individual design. 		TSL-AA

Special products

	Product description	Type marking
	A mobile anchoring point A mobile anchoring point intended for 1 person. The anchoring point construction must be loaded with 250 kg in accordance with the assembly manual. For loading it is possible to use both concrete tiles and green roof layers. The frame dimensions are 1.5 x1.5 m. The delivery does not include the material for anchoring point loading. Made from stainless steel.	TSL-MB
	Topsafe On Top A stainless steel anchoring point intended for flat roofs (up to the maximum inclination of 10°). It is attached to the base by means of fusing with a reinforced covering waterproof without having to perforate the roof membrane. It is only used on roofs with a mechanically anchored waterproof layer! The distributing cross is made from aluminium.	TSL-OT
	Hidden anchoring point A hidden anchoring point suitable for installation on concrete construction of the minimum category C20/25. It can be attached by means of chemical anchor. It is intended for attachment of an anchor eye TSL-S1 and it is supplied in the lengths 100, 150 and 200 mm. The delivery includes a white plastic cover. For attaching in a hidden point, use a special eye TSL-S1 which is not included in the delivery.	TSL-100-B2 TSL-150-B2 TSL-200-B2
	Extension for anchoring points Intended for all types of anchoring points with the column diameter of 16 mm. Supplied in the lengths 100 and 200 mm. Made from stainless steel.	TSL-V3
	Extension for reinforced anchoring points Intended for all types of anchoring points with the column diameter of 42 mm. Supplied in the lengths 100 and 200 mm. Made from stainless steel.	TSL-VR3
	A mobile barrier A mobile barrier intended for delimitation of dangerous zones on the roof. The column is made from stainless steel.	TSL-PFOS
	Ladder securing module A fitting preventing sliding of the ladder. It is installed permanently at the expected place of ascent to the roof. It enables very easy fixing simply clipping it to the gutter.	TSL-LADD

Accessories

	Product description	Type marking
	Anchor eye An accessory for anchoring points. It is included in the delivery of the anchoring point as a standard. When ordering, it is necessary to specify the type: with an external thread / with an internal thread.	TSL-O
	TOPSAFE assembly rope Intended for arresting systems with a temporary flexible anchoring line. Thickness 14 mm. Supplied in the lengths of 15, 23 and 30 m.	TSL-ML
	TOPSAFE SET A roof maintenance set. It includes a safety harness and a moving fall arrester on a flexible line with a fall damper in the required length (5, 10, 15 or 20 m). The set is supplied in a bag.	TSL-SET5 TSL-SET10 TSL-SET15 TSL-SET20
	Self-winding fall restraint It is used for immediate fall arrest. At the moment of falling, the fall depth is restricted with the unwound length of the restraint. The fall restraint keeps the cable slightly tight constantly and thus it reduces the fall depth. Fall restraints can be used for securing both in the horizontal and vertical direction. Shorter fall restraints have a fabric cable, longer fall restraints have a stainless steel cable. Fall restraints can be used both in the interior and the exterior.	With a fabric cable TS-ZCH1 TS-ZCH5 TS-ZCH6 With a stainless steel cable TS-ZCH10 TS-ZCH20
	SAFECARE A metal case for maintenance accessories. Includes two keys.	TSL-SAFECARE
	SAFETHERM Heat insulation covers intended for thermal bridge reduction.	TSL-TH
	Connecting lanyard Y A double connecting means intended for safe transfer between two anchoring devices.	TSL-LANYARD

Anti-slide pavements



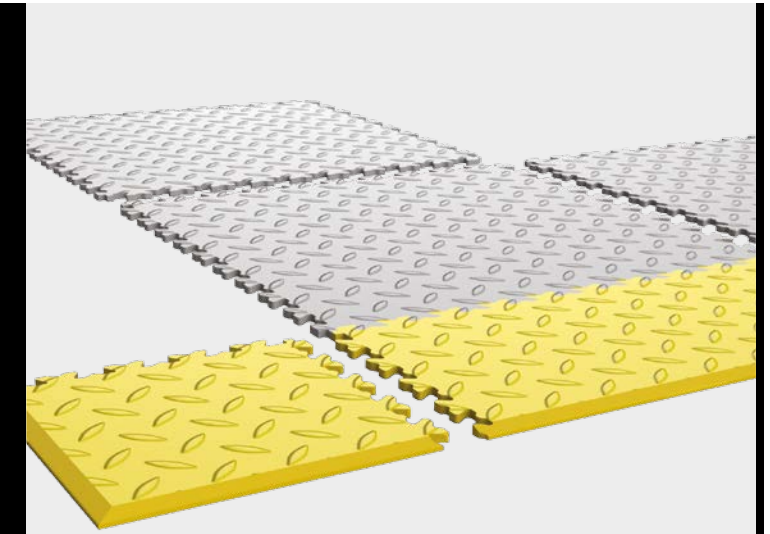

Safe movement on a flat roof

NEW

- For easy creating of Anti-slide routes
- Highly durable and maintenance-free PVC product
- Intended for flat roofs with the main hydro-insulation layer from an mPVC based foil
- The size of each element is 500 x 500 mm
- Elements are UV resistant
- Board thickness 7,3 mm
- Connected with the roof surface by means of hot air
- Color versions: dark gray

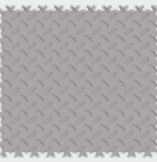

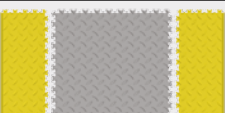
Anti-slide pavements

	Product description	Type marking
	SAFE WALK A modular system from walkable mPVC based panels. Standardised dimensions 500 x 500 mm, thickness 7.3 mm. Dark grey colour.	TS-WALK
	SAFE END + LINE / Borderline End part of the system of traverse parts intended for creation of corridors on the surface of roofs with the main waterproof layer from a mPVC foil. The dimensions of every element TS-END 250 x 500 mm, the thickness of 7.3 mm. Yellow colour.	TS-END
	SAFE CORNER End part of the system of traverse parts intended for creation of corridors on the surface of roofs with the main waterproof layer from a mPVC foil. The dimensions of every element TS-CORNER 250 x 250 mm, the thickness of 7.3 mm. Yellow colour.	TS-CORNER
	SAFE CONTINUOUS SET Continuous part of the system of traverse parts intended for creation of corridors with the width of 1,000 mm on the surface of roofs with the main waterproof layer from a mPVC foil. The set comprises of one TS-WALK part and two TS-END parts.	TS-SIDE-SET
	SAFE STARTER SET The starter and end part of the system of traverse parts intended for creation of corridors with the width of 1,000 mm on the surface of roofs with the main waterproof layer from a mPVC foil. The set comprises of one TS-END part and two TS-CORNER parts.	TS-START-SET

www.topwet.cz

www.topsafe.cz



TOPWET s.r.o. | náměstí Viléma Mrštíka 62 | 664 81 Ostrovačice | Czech Republic
Member of PF GROUP

www.pfgroup.cz